

Vol. 6 No. 9 / \$2

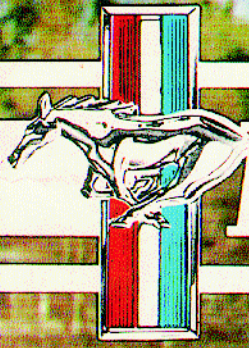

MUSTANG TIMES

September 1982



The Official Publication of

THE MUSTANG CLUB OF AMERICA

NATIONAL PARTS DEPOT

ORIGINAL FORD PARTS • TIRES • BOOKS • MANUALS • DECALS • CARPET • AND MORE

**2nd LOCATION
NOW
OPEN**
1495-C PALMA DRIVE
VENTURA, CA



THE ONE STOP SUPPLIER FOR ALL YOUR MUSTANG NEEDS

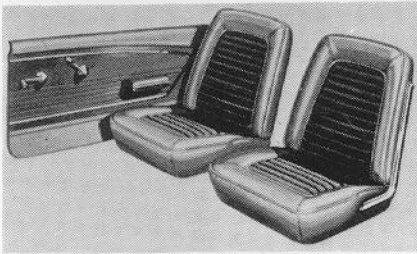

65-69 SEAT UPHOLSTERY

We have in stock all standard type seat upholstery, in all colors for all body types.

SPECIFY YEAR, COLOR, BODY TYPE

Full Set	\$ 179.95
Both Buckets-Complete	\$ 129.95
One Bucket-Complete	\$ 67.95
65-66 Seat Side Shields-Pair	\$ 21.30

Pony Upholstery Available!

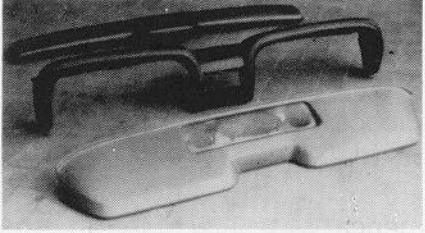

65-73 DASH PADS.

We have a selection in many colors for most years. Prices vary from year to year. Call for more information and free catalog.

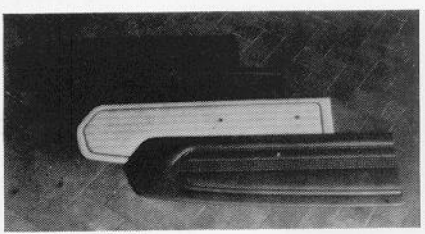

65-69 DOOR PANELS

Reproduced as original with accent trim attached. All colors available. Specify Year, Color, RH, LH

Pair \$99.00

Pony door panel repair covers, molded of one piece vinyl.
65-66 Specify Color Pair \$150
69-73 Specify Color Pair \$250

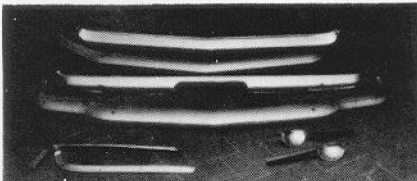

BUMPERS & CHROME PARTS

New 65-72 Front Bumpers	\$ 88.95
New 65-73 Rear Bumpers	\$ 88.95
65-67 GT Light Bars	set \$140.00
65-68 Luggage Racks	\$145.00
65-66 Convertible top belt moldings (Set of 2)	\$ 75.00

IN STOCK

ALL REPRODUCTION SHEET METAL INCLUDING
FLOOR PANS, WHEEL-HOUSES, ROCKERS & PATCH SELECTIONS PLUS ALL NEW
GENUINE FORD FENDERS, QUARTERS, HOODS, TRUNK LIDS, DEFLECTORS, ETC.

We probably have that hard to find part you've been looking for!

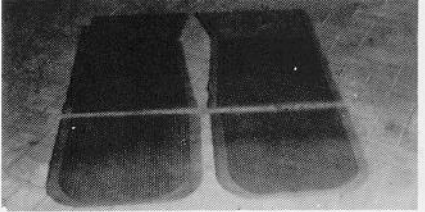

65-73 RUBBER FLOOR MATS

Complete 4 piece front & rear set. Available in white, blue, black, bright red, dark red, green or tan - SPECIFY

Pair \$39.95

65-73 MOLDED CARPETS

Top quality & smooth fit, color-matched heel & toe pads, heavy underpadding, serge bound where original, die cut holes for shifter & dimmer. Available in black, light blue, medium blue, dark blue, red, maroon, green, turquoise, brown, saddle, gold, fawn, emberglow

\$89.95

(2+2 Complete w/fold-down \$104.95)
SPECIFY Color, Year & Body Style



Same Day Shipment On Most Items



Order A Free Catalog Today



CALIFORNIA STORE
IN STATE: 1-800-342-3614
OUT OF STATE: 1-800-235-3445

FLORIDA STORE
IN STATE: 1-904-378-2473
OUT OF STATE: 1-800-874-7595



3101 SW 40th Blvd.
Gainesville, FL 32608

THESE ARE ONLY A FEW OF THE THOUSANDS OF ITEMS WE CARRY FOR MUSTANG — CALL FOR OUR CATALOG TODAY!
5% (\$2.00 Minimum) Shipping Charge. Orders over \$200 prepaid. Truck items freight collect.
NOTE: UPS/COD CUSTOMERS — UPS will require cash or certified payment.
Prices subject to change without notice.
Monday-Friday 8:00 a.m. till 9:00 p.m.
Saturday 8:00 a.m. till 5:00 p.m. • Closed Sunday

1495-C Palma Drive
Ventura, Ca 93003
US 101

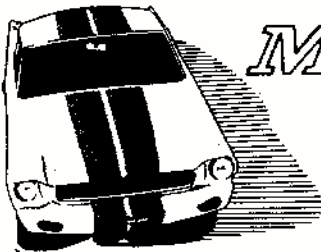

MUSTANGS unlimited inc.

21 Tolland Turnpike, Manchester, CT 06040
(203) 647-1965

MOLDED CARPET SETS - We offer you the finest molded carpet available for your restoration. 80/20 rayon/nylon loop, color-keyed toe and heel pad, original jute backing. The following colors in stock for immediate delivery: black, red, blue, maroon, light green, tobacco, dark green, turquoise, emberglow, saddle, gold, tan.

Coupe, Conv., Fastback \$100.00
Fold down section \$15.00

CONTOURED CARPET SETS - Our sewn carpet sets are of the same quality as our molded carpets and fit perfectly.

64-68 \$65.00
W/Fold Down \$87.00

MUSTANG FLOOR MATS - Original Ford Pony mats. Available in black, red, white, blue, green, tan and maroon.

Set of 4 \$45.00
Fronts, Only \$30.00

Mustang mat with running horse on red, white & blue stripe.

Set of 4 \$24.95
Fronts, Only \$14.95

SHELBY AND MUSTANG CAR COVERS
- Greysfield, 100% cotton perfect fit.
..... \$72.00

TRUNK MATS - Reproduction mats are felt backed. Choice of plaid or speckled design. Specify year & design.
65-70 \$19.50

Original Ford. N.O.S. \$27.00

SPARE TIRE COVER
Speckled or Plaid \$10.95

DOOR PANELS
1965-68 All original colors \$52.00 ea.

AUTHENTIC MUSTANG UPHOLSTERY
- All colors available in all models for 1965, 1966, 1967, 1968. Standard type seat upholstery.

Complete set \$179.95
W/Bench seat \$199.95

Upholstery for two bucket bucket seats \$129.95

Upholstery for one bucket seat \$67.95

PONY INTERIOR SEAT UPHOLSTERY

- 1965-66. The most authentic reproduction of the pony interior is now available. Special attention has been given to the reproduction of the pony insert resulting in a duplication that matches the original in all details.

Upholstery for two bucket seats \$159.00

Upholstery for one bucket seat \$89.00

Complete upholstery for two buckets and back seat \$244.00

Quarter trim upholstery \$39.00 Per Set

MUSTANG HEADLINERS - All original colors available.

65-73 Moonskin \$35.95
Installation Kit \$2.50

REPRODUCTION KICK PANELS - Available in black, red, blue, white and parchment.

65-68 Coupe, Conv., 2+2 \$29.95

CONVERTIBLE TOPS - Our top quality tops are guaranteed for 3 years against defects in material or workmanship. Tops include plastic curtain and instructions. Available in black, white, blue or red.

Convertible Top Pads \$92.00
Convertible Top Pads \$18.00

CONVERTIBLE WELL LINER - Fits in the area between rear seat and trunk. Available in black or white, perfect fit.
..... \$19.50

CONVERTIBLE TOP BOOTS - Exact reproduction of the original. Available for 1964-73 in white, black, ivy, gold, blue, red, palamino, light turquoise, parchment, dark red and light blue.

64-68 \$38.50
69-73 \$40.50

Storage bag for top boot \$4.95
Top boot studs, set of 17 \$8.00

Stud, retainers, set of 17 \$15.00

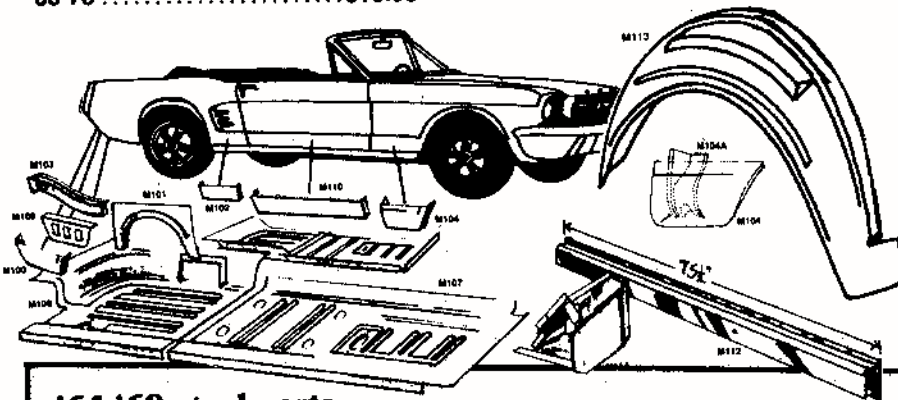

'64-'68 steel parts

M100 64-66 LOWER REAR CORNER \$25.00 ea. has original contour on back, bottom, and wheel opening. 7 1/2" high.
M100A 64-66 LOWER REAR QUARTER \$31.00 ea. has original contour on back, bottom and wheel opening. More than 12" high with offset along top edge.
M200 67-68 LOWER REAR QUARTER \$33.00 ea. has original contour on back, bottom and wheel opening. 13" high with offset.
M101 64-66 REAR WHEEL FLAIR \$33.00 ea. has original contour with 3/4" inner flange.
M201 67-68 REAR WHEEL FLAIR \$33.00 ea. same as early with top offset.
M102 64-66 LOWER PANEL IN FRONT OF REAR WHEEL \$11.00 ea. has lower portion of wheel opening with bottom and front edge included.

M103 64-70 REAR FRAME RAIL \$51.00 ea. has original contour, made from heavy 14 gauge steel with mig welded spring mount. 28" long. Specify right or left, body style.
M104 64-66 LOWER REAR CORNER OF FRONT FENDER \$25.00 ea. includes rear edge to form door opening, extends to 1 1/2" above horizontal body line. 11" high.
M104A 64-66 INNER STRUCTURE LOWER REAR CORNER OF FRONT FENDER \$18.00 ea. exact duplicate of inner structure.
M204 67-68 LOWER REAR CORNER OF FRONT FENDER \$25.00 ea. includes rear edge to form door opening 12" high.
M204A 67-68 INNER STRUCTURE LOWER REAR CORNER OF FRONT FENDER \$18.00 ea. exact duplicate of inner structure.

M106 64-68 SHORT FRONT FLOOR PAN \$44.00 ea. Section in front of seat, extends 4-5" up toward pedals.
M107 64-68 LONG FRONT FLOOR PAN \$49.00 ea. Section under and in front of front seat extends 4-5" up toward pedals.
M108 64-70 REAR FLOOR PAN \$49.00 ea. Section extends behind front seat 21". Original contour extends under lip of rear seat, also extends above seat belt hole on tunnel.
ON FLOORS seat holes and cleanout holes are stamped out completely, like originals.
M111 64-70 DRAIN HOLE COVERLET \$3.25 ea. or \$11.00 set of 4 galvanized, die stamped like original.
M109 64-70 INNER PANEL LOWER REAR CORNER \$21.00 ea. has original ribs, also breaks 1" over on trunk floor.

M110 64-66 LOWER DOOR SKIN \$30.00 ea. wraps around front, back & bottom edges. Has original contour 7 1/2" high.
M112 64-68 INNER ROCKER PANEL \$61.00 ea. conv. renews structural strength of convertible.
Factory 64-70 INNER WHEELHOUSE \$48.00.
M113 64-66 OUTER WHEELHOUSE \$59.00 ea. die stamped in our shops, highest quality.
Factory 67-68 OUTER WHEELHOUSE \$48.00 ea.
M114 64-68 TORQUE BOX \$65.00 ea. conv., die stamped 14 gauge steel.
69-70 FASTBACK OR CONVERTIBLE QUARTER PANELS \$199.00 ea. Specify model.
64-68 REPRODUCTION QUARTER PANELS \$70.00 ea.
M300 69-70 LOWER REAR CORNER \$33.00 ea. Specify Fastback or Conv.

When Ordering: Add 10% For Shipping:
We have, or can get, virtually all Mustang parts and accessories available. We also have an enormous supply of obsolete goodies and used parts in stock. Call or write for specific needs. Look for us at Swap Meets throughout the year.

Mustang and Shelby Parts and Accessories

*Largest Inventory in the Northeast...
We have a lot of things you can't
get from Ford any more!*

TOLL FREE ORDER LINE
1-800-243-7278

Fast UPS Service



1965-1968 MUSTANG



ACCESSORY PONY MATS

Available In:

White
Blue
Red
Burgundy
Black
Green

Set of 4 \$45.00
Front only \$0.00

MOLDED CARPET

Our molded carpets are the best available. All carpets are molded, serge bound, and jute backed as original. The correct heel pad and toe guard are color layed.

1964 1/2-68 (specify color and body style) \$95.00

REPAIR PANELS

1965-66 lower rear corner patch panel each \$21.90
1965-66 inner panel for above each 17.00
1965-66 rear frame rails (specify body type) each 44.50
Mustang Floors:
Rears each \$48.50
Long fronts each \$9.50
Short fronts each \$9.00

DOOR PANELS 1965-1966-1967

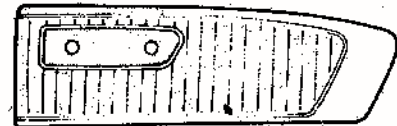

All Original Colors
\$52 each
Specify Year

STANDARD SEAT UPHOLSTERY 1965-1968

Bench seat, front \$149.95
Complete set with bench front 199.95
Complete set (two buckets and rear seat) 179.95
Upholstery for two bucket seats 129.95
Upholstery for one bucket seat 67.95

PONY INTERIOR 1965-66

Upholstery for two buckets \$159.00
Upholstery for one bucket 89.00
Complete set (two buckets and rear seat) 244.00

MANUALS

1965, 66, 67 or 68 each \$25.00
"Mustang Does It" by Ray Miller, covers 1964 1/2-73 Mustang, 320 pages, 1,328 photographs, hardbound with cover \$27.50
Parts catalogs: complete set of original Ford loose leaf parts catalogs, 1965-1972. Covers all models \$60.00

ALL PARTS ARE NEW UNLESS OTHERWISE NOTED

Please add 10% for shipping and handling (minimum \$2) except fenders, hoods and quarter panels, which will be shipped freight collect. Master Charge and VISA are accepted.

NEW MUSTANG CATALOG \$2.00

SATISFACTION GUARANTEED
30-DAY RETURN

1965 Full wheel cover, 13" or 14" ea \$19.00	1965-66 Convertible quarter panel 160.00
1966 Full wheel cover ea 19.00	1965-66 Fastback quarter panel ... 185.00
1965-66 Wire wheel cover (blue center) ea 104.00	1965-66 Dash bezel, specify yr & type 26.75
Spinner and blue center only for above ea 24.50	1967 Dash bezel, black 23.75
1966 Trim ring for styled steel wheels 24.50	1967 Dash bezel, brushed alum 2.00
1965-66 Red center for styled steel wheels 15.00	1968 Dash bezel, black 42.00
1965-67 Lug nuts for styled steel wheels ea 2.95	1968 Dash bezel, woodgrain 42.00
1967 Trim ring for styled steel wheels 24.50	1965 Dash pads (black, red, blue) .. 110.00
1967 Blue center for styled steel wheels 9.00	1966 Dash pads (black, burgundy, blue) ... 110.00
1967 Full wheel cover 19.00	1965-66 Armrest pads, specify color ea 16.00
1967-68 Wire wheel cover (red center) 87.50	1965-66 Chrome armrest bases each 14.00
Red center only for above 15.00	1967-68 Armrest pads, specify year, color ... ea 23.00
1968 Full wheel cover (plain center) 23.50	1965-68 Fuel tank 82.50
1968 Full wheel cover (red center) .. 38.00	1965-66 Trunk mats, specify year, body type . 32.50
1968 Trim ring for styled steel wheel .. 24.50	1965-66 Steering wheel, black 68.50
1966 Chrome hi-po air cleaner 22.50	1965-66 Horn ring for std wheel 28.95
1965-66 GT exhaust trumpets ... pair 88.50	1965-67 Horn ring for woodgrain wheel ... 23.00
1965-66 Chrome trim for GT trumpets ea 8.75	1965-66 Parking lamp assembly 26.95
1965-68 GT or std rear valance, specify year . 42.50	1967-68 Parking lamp assembly 26.95
1965-66 Front bumper 95.00	1965-68 Back-up lamp assy, specify yr. 27.60
1965-66 Rear bumper 95.00	1965-66 Ign, door lock set w/2 "pony" keys 22.50
1967-68 Front bumper 95.00	1965-68 Step plates (specify body type) ... pr 25.00
1967-68 Rear bumper 95.00	1965-68 Accessory step plates (outer) pr 38.50
1965-66 Bumper guards (set of 4) ... 64.00	1967-68 Power brake kit, for drum brakes ... 135.00
1965-68 Front valance, specify year ... 55.00	Cobra alum valve covers, 260-302 .. pr 68.00
1965-66 Rocker panel molding ... ea 43.50	Cobra alum valve covers, 352-428 .. pr 110.00
1967-68 Rocker panel molding ... ea 26.00	1965-66 Hood 195.00
1965 Quarter panel ornament 14.50	1967-68 Hood (specify type) 195.00
1966 Quarter panel ornament 16.00	1965-66 Radiator (specify engine) .. 165.00
1965-66 Outside door handles ea 11.50	1965-68 Luggage rack (except fastback) ... 130.00
1967-68 Outside door handles ea 13.50	1966 Hardtop rear window defroster kit 65.00
1965-66 Tail lamp bezels ea 12.65	1965-66 Rotunda tissue dispenser ... 45.00
1967-68 Tail lamp bezels, 6 reqd ... ea 11.00	1965-66 Rotunda Jr tissue dispenser . 45.00
1965 Grille mesh, specify std or GT .. 47.50	1967-68 Electric qtr mount antenna kit. 60.00
1966 Grille 68.50	1968-70 Chrome wheels, nice used . ea 50.00
1967 Grille 63.50	1967 Styled steel wheels, nice used ea 100.00
1965-67 GT grille bars, specify year pr 135.00	1967-68 Radiator, 289 engine 165.00
1965-67 Fog light assembly ea 55.00	1967 Antenna kit 60.00
1965 Grille ornament "Horse and Corral" ... 54.00	1966 Dash mount clock 75.00
1965 Grille bars, std ea 19.50	1965 Rally-Pac, 8-cyl, nice used ... 200.00
1965-68 Fenders, specify year, side ea 145.00	1965 Foglamp switch, less knob 40.00
1965-68 Coupe quarter panels, specify year . 160.00	1966 Foglamp switch, complete 60.00
	1965-66 Trailer hitch kit 125.00
	C6AZ 17A326-E, 6,000 Cobra tach .. 175.00
	1965-66 Door edge guard kits 25.00
	1965-66 Remote mirror kit 125.00
	Matching rh mirror 75.00



FORD PARTS WAREHOUSE
Courthouse Square, Liberty, KY 42539
PH: 606-787-5031



CLUB OFFICERS

1982 NATIONAL OFFICERS

GEORGE WHITE National President
 JACK YEAGER National Vice-President
 BOBBIE WHITE National Secretary
 BILL KOIVU National Treasurer
 ED HUNTER/KEN YEAGER Sergeants-At-Arms
 TOM GATTIS Chairman, Board of Directors
 JOHN HENDERSON Parliamentarian
 BOB VICKERY National Head Judge
 GORDON R. HARRISON ... National Magazine Publisher

1982 NATIONAL DIRECTORS NATIONAL BOARD OF DIRECTORS

(1/83) JOHN HENDERSON Hixson, Tennessee
 JACKIE MILLS Morrow, Georgia
 EVELYN WOOD Birmingham, Alabama
 HORACE WOOD Birmingham, Alabama
 BILL DILLARD Calhoun, Georgia
 JOHN J. DeROSE Stone Mountain, Georgia
 JIM FARLOW Fairburn, Georgia
 TOM GATTIS Conyers, Georgia
 WALLEY GREENFIELD Grayson, Georgia
 GARY HARTTER Marietta, Georgia
 GORDON HARRISON Doraville, Georgia
 ED HUNTER Powder Springs, Georgia
 JIM HUNTER Powder Springs, Georgia
 BARBARA KOIVU Stone Mountain, Georgia
 BILL KOIVU Stone Mountain, Georgia
 JIM OSBORN Lilburn, Georgia
 SUE OSBORN Lilburn, Georgia
 MARY PARKS Snellville, Georgia
 MEL PARKS Snellville, Georgia
 BERLIN H. PLESS Roswell, Georgia
 JOHN ROGERS Redan, Georgia
 WILLIAM SIMMONS, JR. Stone Mountain, Georgia
 JANE SINGLETON Decatur, Georgia
 BOB VICKERY Lithonia, Georgia
 TERESA VICKERY Lithonia, Georgia
 BOBBIE WHITE Smyrna, Georgia
 FRANK WHITE Marietta, Georgia
 RUTH WHITE Marietta, Georgia
 BRUCE WINCHESTER Lithonia, Georgia
 JACK YEAGER Decatur, Georgia
 KEN YEAGER Decatur, Georgia
 (10/82) LEE GREENFIELD Grayson, Georgia
 (10/85) GEORGE WHITE Smyrna, Georgia

REGIONAL GROUP DIRECTORS

RANDY ADAMS Pony Express River City Mustangs
 JOHN C. BALTES Old Fort Mustangers
 EDDIE CAHEELY Scenic City Regional Group
 HOWARD CRAIG Carolina Region Mustang Club
 RICHARD PITTMAN Eastern North Carolina R.G.
 BOB DOBRINICK Central Illinois Regional Chapter
 JEFF FELTNER Shenandoah Valley Mustang Club
 TED FUTSCHER Peninsula Regional Group
 DON GILLESPIE Mustang Owner's Club of S.E. Mich.
 FRED GLAZIER, JR. First Pennsylvania Mustang Club
 ROBERT HALTERMAN Old Dominion Mustang Club
 TERRY HARRIS Birmingham Mustang Club
 GORDON HARRISON Georgia Regional Group
 RICHARD HEHEMAN Tri State Mustang
 LONNIE HOGAN Lakeway Mustang Club
 TOM HOYT Mid-Missouri Mustangs
 BOB KASPRZAK Mustang Club of S.W. Mich. /N. Ind.
 MIKE LEWIS Texas Panhandle Mustang Club
 KERT MAUL Kansas City Mustang Club
 KEVIN McATEE Treasure State Mustang Club
 BOB MILLER Mid-West Mustang Club
 DOUG OWEN Volunteer Regional Group
 JIM PAYNE The Foothills Regional Group
 MARK SHEHORN Mid-America Regional Group
 KENNETH STANGE Southern Illinois Mustang Assoc.
 ERNIE STOUT First Tennessee Regional Group
 DON TRAVER Aloha Mustang & Shelby Club of Hawaii
 BILL TRIMPE Hoosier Mustang Club
 DAVID WALTERS Gulf Coast Regional Group
 WAYNE WITTE The Wisconsin Early Mustangers
 ED XIQUES Mustangs of Memphis
 CRAIG ZION Central South Carolina Regional Group

DISPLAY ADVERTISING RATES

ad	size	cost
1 page	7-5/16" w x 9-5/8" d	\$120
2/3 page	4-13/16" w x 9-5/8" d	100
1/2 page	7-5/16" w x 4-13/16" d	75
1/3 page	2-1/4" w x 9-5/8" d	55
1/4 page	3-5/8" w x 4-13/16" d	40
1/6 page	2-1/4" w x 4-13/16" d	25

These rates apply to **CAMERA-READY** copy only! Please add 30 percent to rates for non-camera-ready copy. The following discounts will apply to multiple insertions: 3X: 5 percent, 6X: 15 percent, 12X: 25 percent. Specific position (when available): plus 10 percent. Inside cover positions; plus 15 percent. Deadline for all ads is the 10th of the month prior to the cover date month, i.e. June 10 for the July issue. Payment must accompany ad. Please address all display advertising correspondence to Ad Manager, P.O. Box 447, Lithonia, Georgia 30058.

MUSTANG TIMES

The Official Publication of the Mustang Club of America

SEPTEMBER 1982

VOL. 6 NO. 9

Publisher

Gordon R. Harrison

Editor

Josie Knowles

Typography

Custom Composition
Stone Mountain, Georgia

Printing

DeKalb Litho
Avondale Estates, Georgia

Fulfillment

Computer Systems
& Solutions, Inc.
Avondale Estates, Georgia

National Head Judge

Robert Vickery
1470 Stephenson Road
Lithonia, GA 30058

National Regional Group Director

Horace A. Wood
3653 Altadena Drive
Birmingham, AL 35243

Office Manager and Ad Manager

Teresa Vickery
P.O. Box 447
Lithonia, Georgia 30058
(404) 482-4822

TABLE OF CONTENTS

Club Officers	4
Event Calendar	10
Recent Shows	11
Eastern North Carolina Show	12
Mail Bag	14
Deciphering Warranty Plates	16
Car on the Cover	20
1982 World Mustang Expo	24
In Search of Mustangs	28
Membership Application	30
Muffler Puzzler	33
Regional Group News	34
Classified Advertising	38
MCA Accessories	41

(Regional Group Listing will return next month)

For any correspondence pertaining to new membership, club information, renewals, national club business, etc. please send your letter to the national club address:

The Mustang Club of America, Inc.
P.O. Box 447
Lithonia, GA 30058

Mustang Times (ISSN 0744-2572) is published monthly by the Mustang Club of America, Inc., 1470 Stephenson Road, Lithonia, Georgia 30058. Membership dues to the club are \$20 per year which includes \$15 for twelve monthly issues of *Mustang Times*. Second class postage paid at Lithonia, Georgia 30058 and at additional mailing offices. Postmaster: please send address changes to *Mustang Times*, P.O. Box 447, Lithonia, Georgia 30058.

It is requested that any transaction with the club, including dues payment, be made by check or money order made payable to the Mustang Club of America. Cash must be sent

at your own risk. Please notify the club of any change of address immediately and allow a minimum of six weeks.

For urgent business with the Mustang Club of America, the office phone is (404) 482-4822. This is answered from 8-12 a.m. Monday through Friday.

Mustang Times and The Mustang Club of America do not accept any responsibility for the accuracy of advertisements and/or advertisers. Any advertisers who have proved unreliable or who have been named in legitimate complaints from MCA members will not be allowed to advertise. Liability for clerical and/or typographical errors which may appear in *Mustang Times* is limited to the correction of same.

IN MOLDED CARPET
there's only **ONE** name for quality!



**AUTO
CUSTOM
CARPETS**

ALSO AVAILABLE
1969-73 Fastback & Coupe
1969-70 Mach 1 Delux

You can also order delux carpet with rubber mat inserts for 69-70 Mach 1 in the accent red. Other colors available on special order.

*AUTO CUSTOM CARPETS ARE AVAILABLE DIRECT, OR FROM YOUR FAVORITE DEALER.

The Finest Mustang Molded Carpet



**COUPE - CONVERTIBLE - FASTBACKS
- FASTBACKS WITH FOLD DOWNS -**

1964-1/2—1973 Mustang/1967-1973 Cougar—'69-'73 CPU & Fastback, '64-'68 Convertible—'69-'73 Convertible.

1964-68 MUSTANG/1967-68 COUGAR

Nylon loop and cut pile	\$100/set
Coupes and Convertibles	\$110/set
Plush pile and 80/20 rayon/nylon loop	\$110/set
Fastbacks with fold downs	\$125/set
Kick pad carpets for Coupes and Convertibles	\$14.95/set

- We guarantee that you haven't seen a **MUSTANG** carpet that will compare with ours
- All carpets molded and trimmed to fit your car just like the originals — *Perfect fit means easy installation*
- Installation experience not necessary with our carpet — *Perfect results everytime*
- OEM quality, fit and appearance
- We offer the folddown carpet in a diecut package which includes the small corner panels with serged edges. Each panel is diecut for precision fit and can be installed in minutes. **DEALER INQUIRIES WELCOME**

Call Jack Holland
TO ORDER, SIMPLY DIAL TOLL FREE.
1-800-633-2358 1-800-633-2359
INFORMATION: 1-205-236-1118

316 Greenbriar Rd. Anniston, Ala. 36201

* WE SHIP U.P.S./C.O.D. ANYWHERE IN THE CONTINENTAL UNITED STATES. (CANADIAN ORDERS ACCEPTED)

Isn't it worth the call?

If you want it...we got it!

Larry's Mustang Parts

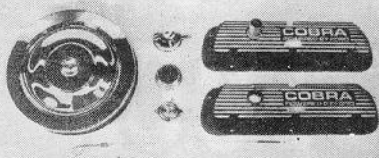

Engine Dress-up Kit—65/73, 260, 289, 302, 351W 119.95

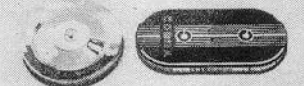

Air Cleaners—Hi-Po 39.95
—Cobra, single or dual 4bbl. 79.95

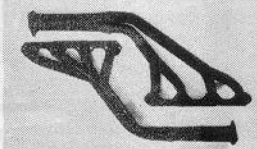

Tri-Y Headers—with installation parts 139.95

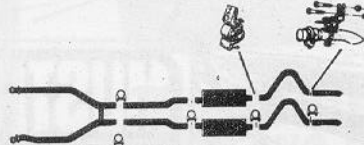

Dual Exhaust Installation Kit—for most years.
(Phone for price and availability)

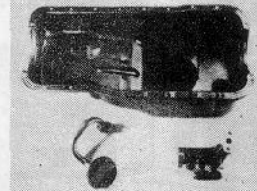

Deep Sump Oil Pan Kit—65/71, 260, 289 302 ... 89.95



Shelby Scoops—65/66 6T350, fiberglass ... pr. 34.95

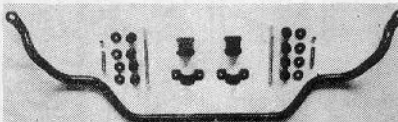

Shelby Type Sway Bar Kit—heavy duty 99.95

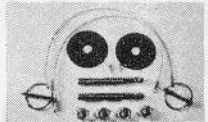

Hood Latch Kit—65/66 14.95

To place parts orders, please call the Toll Free numbers. For your FREE price list, please write and be sure to specify which price list you need (55-57 T-Bird or 65-73 Mustang).

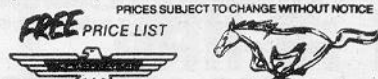

LARRY'S T-BIRD & MUSTANG PARTS INC.
new/used parts • authentic upholstery
PHONE TOLL FREE 800-854-0393
In California call 714-871-6432
511 S. RAYMOND AVE. • FULLERTON, CA 92631



GT Grille Bars and Lamps Kit—65/66 169.95
—67 189.95

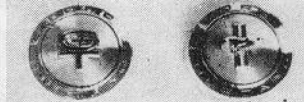

Gas Cap—66 GT 34.95
—66 Standard 32.95



Wood Grain Dash Kit—65/66 32.95



Dual Exhaust Hardware Kit—65/66 65.95



Larry's Mustang Bra—65/73 67.50

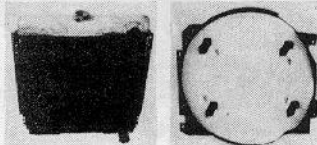

Heavy Duty Radiator—(Phone for price and availability)
Extra Cooling Fan Shroud Kit—65/66, 289 29.95

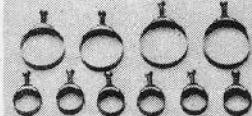

Radiator Hose Clamp Kit—65/73 original type. ... 15.00

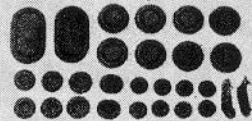

Rubber Plug and Grommet Kit—65/66 19.95
—65/66 with A/C 24.95



Export Brace—65/70 38.35

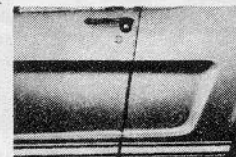

Door Edge Guards—65/66, stainless steel ... ea. 19.95

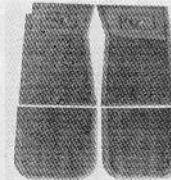

Rubber Throw Mats—65/73 set 45.00



Radio Antenna—65/67 29.50



Battery and Starter Cable Kit—65/66, 8 cyl. 49.95

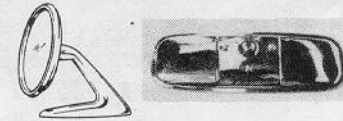

Mirror Assembly—65/66, outside 24.55
—65/66, inside 24.95



License Plate Frame—65/73 ea. 4.00



Air Conditioner Register—65/66, evaporator ... 24.95



Folding Top Weatherstrip Kit—65/66 94.95

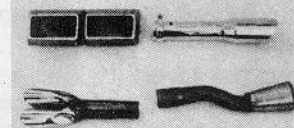

Tail Pipe Extension—(Phone for price)

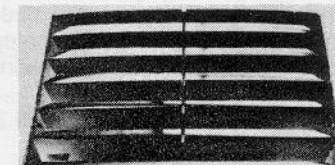

Rear Window Shade—65/73 124.95



Mustang Patch Panels—most panels for most years
(Phone for price and availability)

Complete upholstery including seat covers headliners and doorpanels.

THOUSANDS OF MUSTANG PARTS IN STOCK!

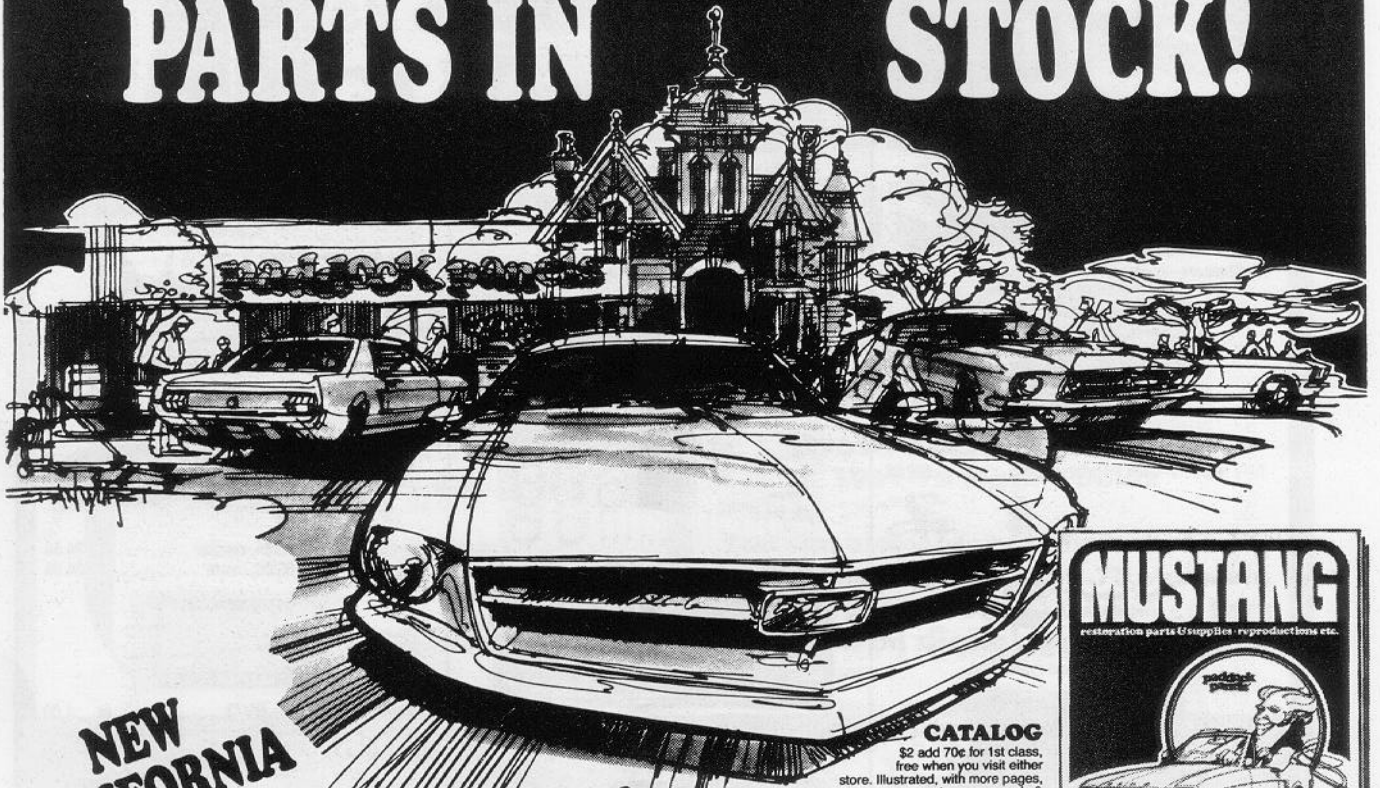

NEW CALIFORNIA STORE!
(we're proud)

We're now shipping parts daily from three warehouses to better serve you. Our new west coast store will offer the same friendly service (John & Mike made the big move) and we're in close contact with all the best sources of parts and supplies for your special needs.

THE BOTTOM LINE! It all boils down to having what you want in stock, giving good service on your order, quick shipment, and a good return policy. We strive to be dependable with your money and needs for your car. Ask any one of our customers and then call us, we'll work hard at pleasing you.

NEW REPRO!

1967-68 FENDER APRON

Order now! Made of 19 ga. American steel with under plate welded in place. Introductory price **\$39**

1965-66 FENDER APRON

Die stamped from 19 ga. steel. Beautiful repro. **\$32**
Order now! Only

FREE SHIPPING! On UPS orders of \$200 or more, items too big for UPS must be shipped, merchandise prepaid by truck with freight charges collect. All orders under \$200 will be shipped with minimum UPS shipping and packaging costs.

CATALOG

\$2 add 70¢ for 1st class, free when you visit either store. Illustrated, with more pages, more parts, more panels & dimensions. Includes 1969 & 70 models and early years. Let us help you rebuild your special interest auto.

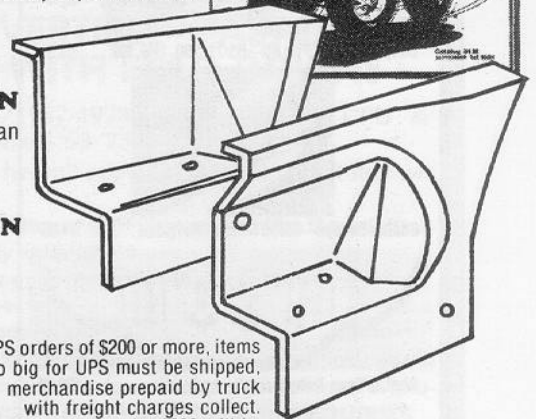
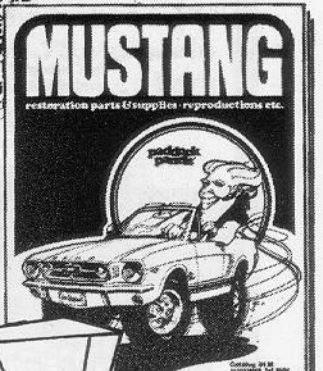

paddock west

446 TENNESSEE ST., DEPT. MT-1 REDLANDS, CA 92373

Call toll free except California, please have order ready. For information on orders and in-state orders, call (714) 798-4166 or 824-3490.

800 854-8532

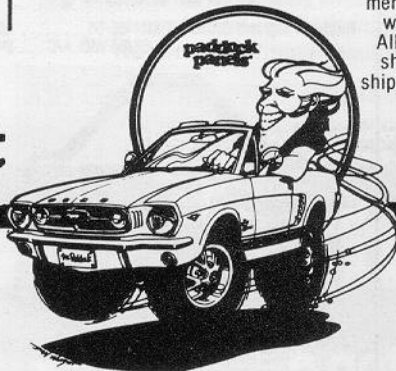

the paddock inc.

38 W. WARRICK, DEPT. MT-1 P.O. BOX 30, KNIGHTSTOWN, IN 46148

Call toll free except Indiana, please have order ready. For information on orders and in-state orders, call (317) 345-2131.

800 428-4319

THE PADDOCK • RACING, RESTORING & MAKING REPRODUCTIONS FOR SPECIAL INTEREST CARS SINCE 1965!

OPEN THE DOOR



If You Don't
See What You
Want Here...
Call, We
Probably Have
It!

**TO AN ENTIRE WORLD OF
MUSTANG PARTS AND ACCESSORIES**

SPECIALIZING IN THE MANUFACTURING OF **DOOR PANEL SKINS**

- ★ 1965, 1966 Pony Molded Vinyl Door Panel Skinspr. **\$165.00**
- ★ 1967 Molded Vinyl Door Panel Skinspr. **\$165.00**
- ★ 1969 and 1970 Deluxe Molded Vinyl Door Panel Skins.....pr. **\$270.00**
- ★ 1971 thru 1973 Deluxe Molded Vinyl Door Panel Skinspr. **\$270.00**

- ★ 1965 and 1966 Convertible or H/T Kick Panelspr. **\$30.00**
- ★ 1964, 1965 and 1966 Molded Carpet Setspr. **\$110.00**
- ★ Rear Area for F/Bea. **\$15.00**

*Also Carry Complete Line Of
Upholstery 65-68*

IN STOCK

- ★ Convertible Tops 65-73
- ★ All Rubber Seals 65-73
- ★ N.O.S. Chrome Parts 65-73
- ★ Rechromed Parts 65-73
- ★ Sheet Metal 65-73
- ★ Hard To Find Used Parts

Send For FREE Parts List

FOR ORDERS CALL: 1-800-327-3640 Outside Fla.

Bill B. Heshner

315 South Hopkins
Titusville, Florida 32780

305/267-4175

8:30 A.M. to 5:00 P.M.
Monday thru Friday

EVENT CALENDAR

1982



- September 3-5 1982 Seventh Annual Grand National, Valley Forge, Pennsylvania
Host: First Pennsylvania Mustang Club (215) 723-9674/Host Hotel: Stouffer's Valley Forge, King of Purssia, Pennsylvania 19406. For reservations, call (215) 337-1800.
- September 4-5 Fourth Annual National Expo Ford '82 Swap Meet and Car Show, Ricart Ford, Columbus, Ohio, and All Ford/Mercury Drag Race at National Trail Raceway.
Host: Central Ohio Region, Performance Ford Club of America. Call (614) 836-5321.
- September 11 Rally & Swap Meet, Mitchell & Howell Ford, Martinsville, Va. Rain Date: Sept. 18
Host: First Piedmont Regional Group
- September 11-12 Sixteenth Beaulieu Autojumble, Europe's Largest Swap Meet, National Motor Museum, Beaulieu, Hampshire, England
Host: Thoroughbred and Classic Cars Magazine. Contact Montagu Ventures Limited, John Montagu Building, Beaulieu, Hampshire, S04 7ZN
- September 12 1982 Fourth Annual Mustang Roundup, Pointe Mallard, Decatur, Alabama
Host: North Alabama Mustang Club, Inc. Call (205) 355-0870
- September 12 Second Annual Mustang x Shelby Car Shows and Swap Meet, Millville, New Jersey Municipal Airport
Host: South Jersey Regional Mustang Club. Call (609) 696-8643
- September 17-19 Fall Virginia Antique Car Flea Market Collector Car Round-Up and Show, Expoland, Fisherville, Virginia. Call (703) 337-2552 or 943-EXPO
- September 18 First Annual Auto Show and Swap Meet, Le May's Resort, Wind Lake, Wisconsin
Host: TBA Auto Magazine and Brewtown Cruisers Mercury Car Club of Milwaukee, Chapter of Mid-Century Mercury Club of Kenosha
- September 18 Fourth Annual Mustang and Shelby Shows, All Day Swap Meet, Athenian Community Park, Athens, Illinois. Call 636-8855 or 636-8049.
- September 19 Third Annual Mid-Kansas Mustang Club Round-Up, Reimer Ford-Lincoln-Mercury, 2075 E. Kansas Avenue, McPherson, Kansas
Host: Mid-Kansas Mustang Club. Call (316) 241-0026 or 241-1042
- September 25-26 Car Show at Wade Ford, S. Cobb Dr. Marietta, Georgia
Host: Georgia Regional Group
- September 26 First Annual East Coast Drag Day Car Show, Lebanon, NY Valley Speedway
Host: Adirondack Shelby-Mustang Club, Inc., SAAC. Call (518) 885-9013 or 384-0493
- October 2-3 Third Annual Car Show, "SD '82," Sea World, San Diego, California
Host: San Diego Mustang Club (717) 440-1123 or 265-7319
- October 3 Auto Parts Swap Meet, Youth Center Building, Jones County Fairgrounds, Monticello, Iowa. Call (319) 465-5119 or 465-5380
- October 3 First Annual MCCNE Automotive Swap Meet, Sac Park, Lake St., Shrewsbury, Massachusetts.
Host: Mustang Car Club of New England.
- October 22-24 Great Pumpkin Rally, Car Show, Parts Swap, More
Host: Copperstate Mustang Club of Phoenix, Arizona
- October 23-24 Street Machine Nationals, Pomona, California
Host: Car Craft Magazine, Petersen Publishing Company. Call (213) 657-5100, ext. 485
- November 12-14 Second Annual Atlanta Vintage Grand Prix, Road Atlanta
Host: Southeast Vintage Racing Association, Inc. Call (813) 385-2486.

75,000 Attend Car Craft Event

Street machine history was rewritten June 25-27 in Springfield, Illinois, where nearly 75,000 automotive enthusiasts checked into the largest event of its kind in the world: CAR CRAFT Magazine's Sixth Annual Street Machine Nationals.

Five thousand 1949-and-newer vehicles were pre-entered from as far away as California. Rewards for lucky participants ranged from massive peer approval to \$56,000 in trophies, merchandise awards and give-away prizes, including a customized 1982 Camaro Z28 valued at \$22,000.

More than 100 sponsoring companies participated in the Illinois State Fairgrounds festivities. Various participant judging contests and luck-of-the-draw prize give-aways were sponsored.

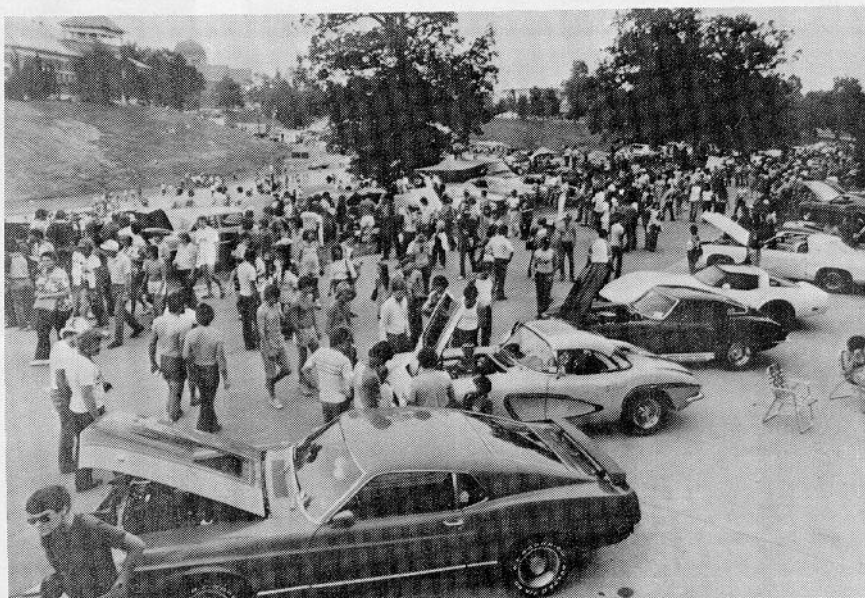

Car Craft's 1982 Springfield Street Machine Nationals.

Action, Fun Spark Omaha Car Show

The Mustang Car Club of Omaha held its 3rd Annual Car Show in Blair, Nebraska, June 18-20, in conjunction with the Blair Farm-a-Rama. After two years of success with one day car shows, the Mustang Car Club of Omaha members decided to try their luck with a weekend extravaganza.

A first time treat for this part of the U.S. was the appearance of the Ford Motor Sports Caravan. The display included a McLaren Mustang, Rutherford's Indy car, a Mustang GT Enduro car, Glidden's EXP Pro 2 replica, and a Cosworth Capri. The display was on exhibition throughout the weekend and was a real crowd pleaser!

Saturday morning dawned sunny and warm, another unusual phenomenon for the midwest in 1982! More than 100 Mustang owners took advantage of the picture perfect weather and entered their cars in the judged show. This event took place at the Blair airport, providing a beautiful setting for the show. Each car was judged by a team of three judges comprised of members of the Mustang Car Club of Omaha, the Central Iowa Mustang Club, and the Mid-

Missouri Mustangers. Best of Show was awarded to Ken Pauley of Kansas City, Missouri for his beautiful 1970 Boss 302.

Saturday evening's banquet was followed by the awarding of numerous door prizes and trophies. Speakers of the evening were Bob Woodhouse of Woodhouse Ford who spoke about Ford in 1983 and Bob Ridder, General Manager of Motor Sports Journal, who spoke of motor sports in the Omaha area. Topping off the evening was the viewing of a full length feature film about a Mustang.

The weather again cooperated Sunday allowing everyone to enjoy the fun filled finale. Slalom racing was held at the Blair Plaza. Bob Woodhouse in his 1972 Pantera turned the fast time of the day despite the fact that he was operating the throttle by hand, having broken the throttle during his first run.

The Popular Vote car show included classes for all years and styles of Mustangs, Bosses, Shelys, Panteras, T Birds, Cougars, and special interest Fords of all types. Thanks to the Blair Arrows, the vendors utilized a large

airplane hanger as swap space. The show participants chose a 1968 Shelby GT 350 owned by Vince and Deb Jauron from Harlan, Iowa as Best Original. Chosen for Best of show was a 1969 Mach I owned by Larry and Dianne Everhart from Merville, Iowa. Other special awards were given to the Blair Chamber of Commerce and to the area Ford Clubs who participated and helped with the event.

Also available to the participants throughout the weekend were Blair Farm-a-Rama events including pancake breakfasts, Ultralight plane shows, helicopter rides, a street dance and a chance to show off their cars in a large parade. All styles and years of Mustangs were well represented in the parade.

More than 200 cars were entered in the weekend's festivities and more than 3,000 spectators viewed the cars. From every aspect, the Third Annual Mustang Car Club of Omaha Show was a success. Try not to miss next year's fourth annual meet that promises to be the biggest and best ever!

Debra Jauron

Eastern North Carolina Holds 2nd Annual Show

July 10th was Mustang Day in Cary, NC and at Cary Village Mall. A total of 78 Mustangs were displayed for show and/or sale, along with about ten parts vendors. This was the Second Annual Mustang Show for the Eastern NC Regional Group, and we doubled the number of cars that were entered last year. The merchants at the mall were very pleased with the crowd that we drew and have invited us back next year.

We had thirteen classes with first, second, and third place trophies in each and an overall Best of Show Trophy.

1964½-1973 Best of Show

Richard Pittman, Raleigh, NC

1964½-1966 Street Driven

	1st	2nd	3rd
Coupe	Jerry Bynum Cary, NC	Jessie Gardner Garner, NC	Anna Lane Raleigh, NC
Conv.	Bobby Dodd Danville, NC	Bobby Edwards Cary, NC	Walter Carr Roanoke, VA
2+2	Vance Ward Raleigh, NC	Butch Strickland Rockingham, NC	

1967-1968 Street Driven

	1st	2nd	3rd
Coupe	Bill Wilson Raleigh, NC	Richard Guidotti Cary, NC	Bobby Edwards Cary, NC
Conv.	Al Vinal Cary, NC	Neal Caliendo Raleigh, NC and Joe Lawhorn Garner, NC	Bob Gage Raleigh, NC
2+2	None Entered		

1969-1973 Street Driven

No Mustangs entered in these three classes.

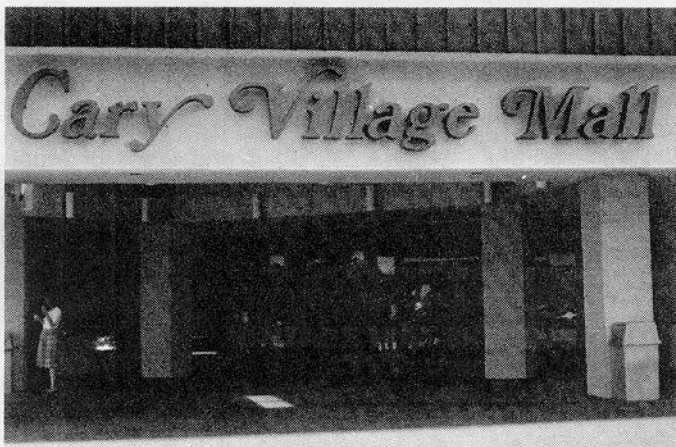

1965-1973 Shelby, BOSS and MACH I

1st	2nd	3rd
Randall Cecil High Point, NC	Ted Stables Cary, NC and Mike Barnett New Bern, NC	Wayne Beasley Morehead City, NC

1964½-1973 Show Class

1st	2nd	3rd
Bob Summers Gibsonville, NC	Wayne Beasley Morehead City, NC	None

1964½-1966 Modified

1st	2nd	3rd
Fred Carter Durham, NC	George Mitchell Norlina, NC	John Fitts Wendell, NC

1964½-1973 Peoples Choice

1st	2nd	3rd
Al Vinal Cary, NC	John Fitts Wendell, NC	Jessie Gardner Garner, NC

In addition to all the Mustangs entered, there were many more in the adjacent lot owned by people coming to see the show. Many of these were also high quality cars. The Awards Banquet was held at 7:00 at Ballentines Restaurant on the mall.

The Eastern NC Regional Group thanks everyone who attended our show for helping to make it a success. We hope to see ya'all next year at our Third Annual Mustang Show.

Richard Pittman
Show Coordinator



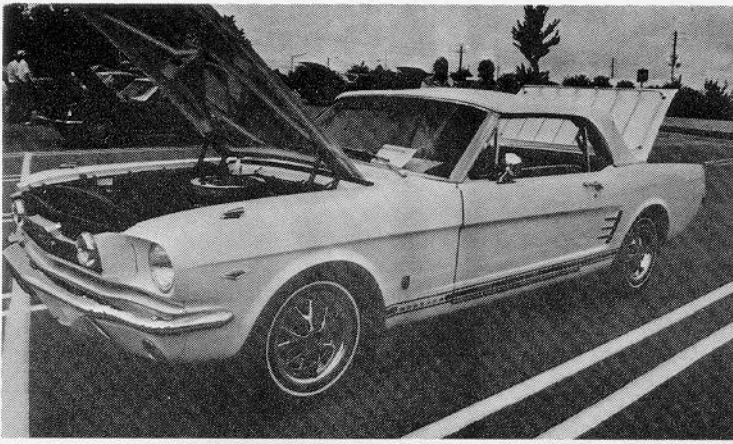

Bob Summer's First Place Winner



Ted Stables' Shelby

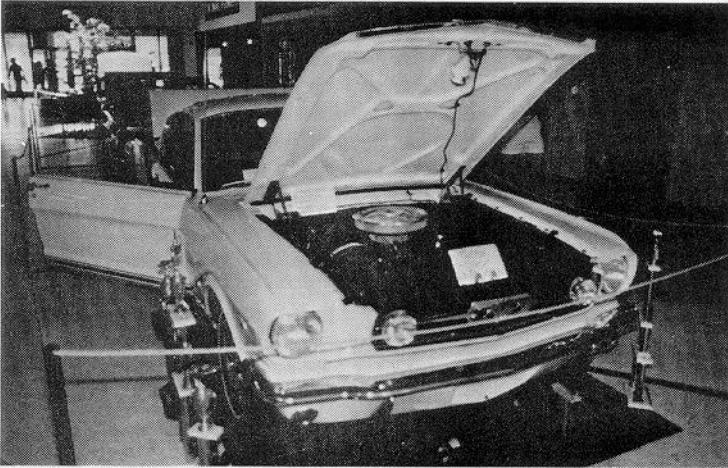

Pittman's Best of Show



Al Vinal's People's Choice



Jimmy Miller's Convertible

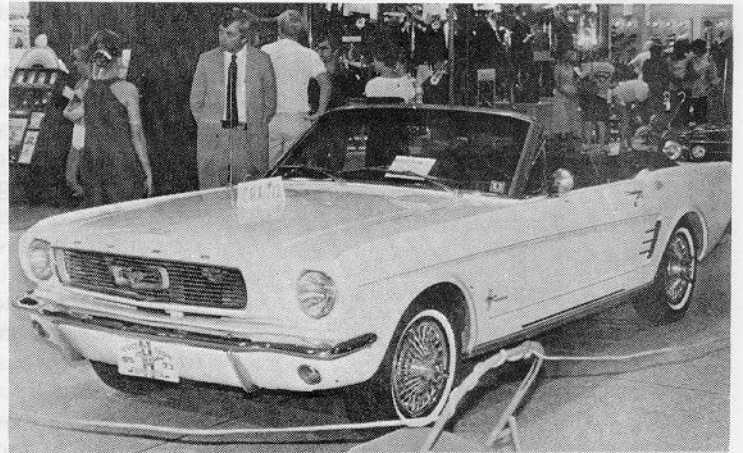

Jim Miller's Convertible



Bobby Edwards' Winner

MAIL BAG

Orchids . . .

I am a member of The Mustang Club of America, No. 8016; Regional Group, Gulf Coast Club.

Being a relatively new member, I would like to take this opportunity to compliment the National Club and your fine publication. It has certainly been a pleasure to be associated with such a fine organization and I look forward to receiving your magazine each month.

Keep up the good work!

John G. Wiley
Pensacola, Florida

Loved (Teresa Vickery's) car and the story in the July issue. My husband and I agree that it was the best *Mustang Times* ever.

Linda Bowes
Hatboro, Pennsylvania

Just a fast note to say that I enjoy *Mustang Times* and that the articles and "ads" have been a big help!

Someday, I hope that my '65 convertible will be finished, if possible!?

Keep up the good work!

Malcolm B. Elder
Ft. Edward, New York

Enjoy your publication. Keep up the good work.

Donald J. Matson
Mount Prospect, Illinois

... First, I want to congratulate you and your staff for the tremendous improvement in the appearance of the magazine and its content. Notwithstanding the fact that my car was featured on the June cover, this issue is the best one yet.

Second, I want to express my grateful appreciation to you and your staff for the generous coverage you gave my car in the June issue. I knew Teresa and Bob Vickery would take some good pictures of the car, but their results were astonishing and truly professional. Those photos made all the hard work restoring the car worthwhile.

I also want to express my appreciation to all those MCA members and officials at the Eastern Regional Meet at

the Marriott on Memorial Day weekend who extended me so much friendship and courtesies when I arrived to display my car at the show. That was the first time I have ever publicly displayed one of my cars and I was a real novice. George White, Bob and Teresa Vickery and the Yeagers, Jack and Ken, were extremely helpful. The entire experience was very rewarding for me. The only tense movements of the entire weekend came when driving the car to and from the show from Covington, Ga. The Mustang was right at home in that "Indianapolis 500" type traffic on I-285 & I-75, though.

I didn't mean to get so windy, but wanted to thank all of you properly for displaying my rare car so beautifully.

Robert (Reg) Prescott
Covington, Georgia

. . . And An Onion

To say that I was disappointed with the July 1982 issue of *Mustang Times* would be a gross understatement of fact; more accurately, I was totally disgusted. I have no quarrel with the idea of Vickery's Mustang being the featured car, but I wonder if any other members considered the means of presentation to be questionable, both in format and taste. Addressing the former: Since when does a member rate an "interviewer"? I've never seen this treatment in the years I've been a member. The entire story seemed to be self-serving. Along the same lines, the Vickerys were mentioned at least a half-dozen times, by estimate, throughout the issue. This patting-on-the-back tends to appear a bit clanish at face value. Regarding Taste: The one picture in the article, and I don't believe I need to be more specific, demonstrated a complete lack. To allow, much less submit, such a photo to be printed in *Mustang Times* takes a lot of guts and no class whatsoever. In *Car Craft* it's expected; in *Mustang Times* it's unexcusable. Interesting to note the photographer was Mr. Vickery . . . I hope the editor will exercise a little more discretion in the future and concentrate on improving the content of this publication rather than resorting to such childish exhibitionism and back-patting as evidenced in the feature article. Other

members may or may not agree with my stance; I think the *Mustang Times* could be a far better publication by simply screening its material with an eye towards quality.

C. Marc Shirley, R.Ph.
MARx Mustang Parts
Zionsville, Indiana

Since I became editor, members rate interviews. Did you miss the April issue?

Used correctly, the term "self-serving" would apply only if Mrs. Vickery herself had written the article. If you mean that I was serving my own purposes by idly flattering Mrs. Vickery, let me assure you that I "called the shots as I saw them"; my description of Mrs. Vickery as a hard working and loyal member of MCA is the result of my personal observation over the past six months. Because Mrs. Vickery deals with MCA members all over the US, most of whom have never met her, I purposely included a lot of details, because I thought these members would find them of interest.

The Vickerys are in the magazine a lot because they do a lot for the Club.

There was no purient intent in the photograph; I'm sorry you saw it that way.

J. Knowles

Expo Renewed Him

After a full year's membership to the MCA, a friend and I scratched up enough money to drive down to our first Mustang meet, The World Mustang Expo in Chattanooga. May I just



Feldman Trailers
Box 1587
Bowling Green, Kentucky 42101
(502) 843-4587 No. can deliver anywhere. 782-2734



• PERFORMANCE PARTS / BUY, SELL and TRADE
• MUSTANGS PARTS
Snakeman Enterprises
Harvard Still
Contact "Snakeman"
615/479-7314 • RT. 9 BOX 588 • CLEVELAND, TENNESSEE 37311

say that on the way down I was wondering if I should renew my membership, which was due to expire this month. But once I arrived on the show site, I bit the dust once again. That's right. Mustang Fever!

I had never seen such a fine collection of automobiles in one place at one time. Some of my favorites were the cover cars, from Teresa Vickery's Mach I to Ken Stange's "Ivy" 1965. I was also thrilled to see a T-5 for the first time. The location, as well as the host, was very nice and everything was ideal for my first Mustang show. Thank you, Scenic City Regional Group, for such a great time!

As for my membership, please extend it for one more year, and I won't wait as long this term to go to a nationally sanctioned show. I'm afraid I spent most of my money on the Chattanooga trip, so my check will be a little late, but please don't let me miss an exciting issue of *Mustang Times*!

Randy Webber
Clinton, Tennessee



1965 - 70
MUSTANG

New Parts
Upholstery
Accessories

- Trunk Mats — plaid or speckled custom tailored for all models 65-70 specify body style; only \$21.95
- Seat Upholstery — complete sets, any color from \$194.95, pony style for 1965-66 models also available
- Floor Mats — heavy rubber with raised running Mustang, fronts only, \$29.95; fronts and rears \$39.95; for all years and models (specify color)
- Radiators — O.E.M., new complete radiators, just bolt-in, from \$125.

Send For Your **FREE** Price List Today!

Shipping—10% on orders less than \$150, all others shipped free.
All C.O.D.'s add \$1.50, CA residents add sales tax.
VISA, Master Charge welcome

427 N. Anaheim Bl., Dept. F
Orange, CA 92668
(714) 634-4936

CLASSIC
INSURANCE AGENCY

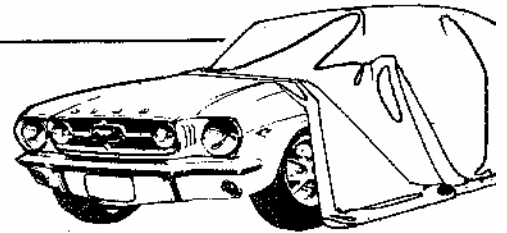

Announces

“Blanket Protection”

A full stated amount insurance program designed to meet the needs of Mustang owners, and all collectors, including those specializing in late model and high performance automobiles.

Classic's new “BLANKET PROTECTION” program is affordably priced insurance that includes **LIABILITY** (in most states) and full stated amount coverage for fire, theft and collision.

If you drive your special car 2500 miles or less a year and you would like more information about this coverage call us toll free at:

(800) 631-1363

In Georgia: (404) 955-8787

Classic Insurance Agency • 1 Perimeter Way, N.W. • Atlanta, GA 30339

MIDWEST



MUSTANG

GRAND
OPENING!!

WE CARRY
A COMPLETE LINE
OF MUSTANG PARTS
FROM 1964½ - 73

SEND \$2.00 FOR
PARTS CATALOG
(Money credited upon first purchase)

CALL COLLECT OUTSIDE ILLINOIS
1-815-962-3332

MIDWEST MUSTANG

(815) 962-3332 • 1325 Broadway • Rockford, Illinois 61108

Part seven in a series, How to Break Down Your Mustang Warranty Plate

1964½ INTERIOR TRIM

CODE TRIM DESIGN

42	White Vinyl w/Blue Trim
45	White Vinyl w/Red Trim
46	White Vinyl w/Black Trim
49	White Vinyl w/Palo. Trim
56	Black Vinyl w/Cloth
82	Blue Vinyl w/Blue Trim
85	Red Vinyl w/Red Trim
86	Black Vinyl w/Black Trim
89	Palomino Vinyl w/Palo. Trim

This month's article deals with the many different types of Mustang interiors. To find yours, look at the warranty plate and find the word TRIM. Match the number with the below list. Any questions? Write Jon Whittington, 106 South Urbana IL 61801. Please include a SASE for response.

1965 INTERIOR TRIM

CODE TRIM DESIGN

CODE TRIM DESIGN	BODY TYPE	
22	Medium Blue Crinkle all Vinyl	63A, 65A, 76A
25	Red Crinkle all Vinyl	63A, 65A, 76A
26	Black Crinkle all Vinyl	63A, 65A, 76A
28	Light Ivy Gold Crinkle all Vinyl	63A, 65A, 76A
29	Medium Palomino Crinkle all Vinyl	63A, 65A, 76A
32	Medium Blue Crinkle all Vinyl	65C, 76C
35	Red Crinkle all Vinyl	65C, 76C
36	Black Crinkle all Vinyl	65C, 76C
39	Medium Palomino Crinkle all Vinyl	65C, 76C
42	White Crinkle all Vinyl w/Blue	63A, 65A, 76A
45	White Crinkle all Vinyl w/Red	63A, 65A, 76A
46	White Crinkle all Vinyl w/Black	63A, 65A
46	White Crinkle all Vinyl w/Blue	76A
49	White Crinkle all Vinyl w/Palomino	63A, 65A, 76A
56	Black Crinkle Vinyl w/Black Cord Pattern Cloth	65A
62	Light Blue and White Crinkle all Vinyl	63B, 65B, 76B
65	Red Crinkle all Vinyl	63B, 65B, 76B
66	Black Crinkle all Vinyl	63B, 65B, 76B
67	Light Turquoise and White Crinkle all Vinyl	63B, 65B, 76B
68	Light Ivy Gold and White Crinkle all Vinyl	63B, 65B, 76B
69	Medium Palomino Crinkle all Vinyl	63B, 65B, 76B
76	Black Crinkle Vinyl w/Black Cord Pattern Cloth	63A, 65A
79	Medium Palomino Crinkle Vinyl w/Light Palomino Cord Cloth	63A, 65A
80	White all Vinyl	63A, 65A, 76A
82	Medium Blue Crinkle all Vinyl	63A, 65A, 76A
85	Red Crinkle all Vinyl	63A, 65A, 76A
86	Black Crinkle all Vinyl	63A, 65A, 76A
88	Gold all Vinyl	63A, 65A, 76A
89	Medium Palomino Crinkle all Vinyl	63A, 65A, 76A
D2	White Crinkle w/Blue all Vinyl	63A, 65A, 76A
D5	White Crinkle w/Red all Vinyl	63A, 65A, 76A
D6	White Crinkle w/Black all Vinyl	63A, 65A, 76A
D8	White Crinkle w/Ivy Gold all Vinyl	63A, 65A, 76A
D9	White Crinkle w/Palomino all Vinyl	63A, 65A, 76A

1965 INTERIOR TRIM (continued)

CODE TRIM DESIGN	BODY TYPE
F2 White Crinkle w/Blue all Vinyl	63B, 65B, 76B
F5 White Crinkle w/Red all Vinyl	63B, 65B, 76B
F6 White Crinkle w/Black all Vinyl	63B, 65B, 76B
F7 White Crinkle w/Turquoise all Vinyl	63B, 65B, 76B
F8 White Crinkle w/Ivy Gold all Vinyl	63B, 65B, 76B
F9 White Crinkle w/Palomino all Vinyl	63B, 65B, 76B
321 Medium Blue Crinkle all Vinyl	65C, 76C
361 Black Crinkle all Vinyl	65C, 76C

1966 INTERIOR TRIM

CODE TRIM DESIGN	BODY TYPE
22 Light Blue Crinkle Vinyl w/Medium Blue Rosette Pattern Vinyl	63A, 65A, 76A
22A Light Blue Crinkle Vinyl w/Medium Blue Crinkle Vinyl	65A, 76A
25 Red Crinkle Vinyl w/Red Rosette Pattern Vinyl	63A, 65A, 76A
25A Red Crinkle all Vinyl	65A, 76A
26 Black Crinkle Vinyl w/Black Rosette Pattern Vinyl	63A, 65A, 76A
26A Black Crinkle All Vinyl	65A, 76A
27 Light Aqua Crinkle Vinyl w/Medium Aqua Rosette Pattern Vinyl	63A, 65A, 76A
27A Light Aqua-Medium Aqua Crinkle all Vinyl	65A, 76A
32 Light Blue Crinkle Vinyl w/Medium Blue Rosette Pattern Vinyl	65C, 76C
35 Red Crinkle Vinyl w/Red Rosette Pattern Vinyl	65C, 76C
36 Black Crinkle Vinyl w/Black Rosette Pattern Vinyl	65C, 76C
62 White and Light Blue Crinkle All Vinyl	63B, 65B, 76B
64 Parchment-Medium Emberglo Crinkle all Vinyl	63B, 65B, 76B
65 Red Crinkle all Vinyl	63B, 65B, 76B
66 Black Crinkle all Vinyl	63B, 65B, 76B
67 White-Light Aqua Crinkle all Vinyl	63B, 65B, 76B
68 White-Light Ivy Gold Crinkle all Vinyl	63B, 65B, 76B
C2 Parchment Crinkle Vinyl w/Parchment Rosette Pattern Vinyl w/Blue	65C, 76C
C3 Parchment Crinkle Vinyl w/Parchment Rosette Pattern Vinyl w/Burgundy	65C, 76C
C4 Parchment Crinkle Vinyl w/Parchment Rosette Pattern Vinyl w/Emberglo	65C, 76C
C6 Parchment Crinkle Vinyl w/Parchment Rosette Vinyl w/Black	65C, 76C
C7 Parchment Crinkle Vinyl w/Parchment Rosette Pattern Vinyl w/Aqua	65C, 76C
C8 Parchment Crinkle Vinyl w/Parchment Rosette Pattern Vinyl w/Ivy Gold	65C, 76C
C9 Parchment Crinkle Vinyl w/Parchment Rosette Pattern Vinyl w/Palomino	65C, 76C
D2 Parchment Crinkle Vinyl w/Parchment Rosette Pattern Vinyl w/Blue	63A, 65A, 76A
D2A Parchment Crinkle Vinyl w/Blue	65A, 76A
D3 Parchment Crinkle Vinyl w/Parchment Rosette Pattern Vinyl w/Burgundy	63A, 65A, 76A
D3A Parchment Crinkle Vinyl w/Burgundy	65A, 76A
D4 Parchment Crinkle Vinyl w/Parchment Rosette Pattern Vinyl w/Emberglo	63A, 65A, 76A
D4A Parchment Crinkle Vinyl w/Emberglo	65A, 76A
D6 Parchment Crinkle Vinyl w/Parchment Rosette Pattern Vinyl w/Black	63A, 65A, 76A
D6A Parchment Crinkle Vinyl w/Black	65A, 76A
D7 Parchment Crinkle Vinyl w/Parchment Rosette Pattern Vinyl w/Aqua	63A, 65A, 76A
D7A Parchment Crinkle Vinyl w/Aqua	65A, 76A
D8 Parchment Crinkle Vinyl w/Parchment Rosette Pattern Vinyl w/Ivy Gold	63A, 65A, 76A
D8A Parchment Crinkle Vinyl w/Ivy Gold	65A, 76A
D9 Parchment Crinkle Vinyl w/Parchment Rosette Pattern Vinyl w/Palomino	63A, 65A, 76A
D9A Parchment Crinkle Vinyl w/Palomino	65A, 76A
F2 Parchment-Palomino Crinkle all Vinyl	63B, 65B, 76B
F3 Parchment-Burgundy Crinkle all Vinyl	63B, 65B, 76B

1966 INTERIOR TRIM

CODE TRIM DESIGN	BODY TYPE
F4 Parchment-Emberglo Crinkle all Vinyl	63B, 65B, 76B
F6 Parchment-Black Crinkle all Vinyl	63B, 65B, 76B
F7 Parchment-Aqua Crinkle all Vinyl	63B, 65B, 76B
F8 Parchment-Ivy Gold Crinkle all Vinyl	63B, 65B, 76B
F9 Parchment-Palomino Crinkle all Vinyl	63B, 65B, 76B
2DA Parchment Crinkle all Vinyl	65A, 76A

The "A" after some 1966 trim codes stands for crinkle vinyl (1965 style) instead of rosette pattern (1966 style).

1967 INTERIOR TRIM

CODE TRIM DESIGN
2A All Black
2B All Blue
2D All Red
2F All Saddle
2G All Ivy Gold
2K All Aqua
2U All Parchment
4A All Black-Bench Seat
4U All Parchment-Bench Seat
5A All Black-Comfortweave Luxury
5U All Parchment-Comfortweave Luxury
6A All Black-Luxury
6B All Blue-Luxury
6D All Red-Luxury
6F All Saddle-Luxury
6G All Ivy Gold-Luxury
6K All Aqua-Luxury
6U All Parchment-Luxury
7A All Black-Comfortweave
7U All Parchment-Comfortweave

1968 INTERIOR TRIM

CODE TRIM DESIGN
2A,6A* Black Vinyl
2B,6B* Blue Vinyl
2D,6D* Red Vinyl
2F,6F* Saddle Vinyl
2G,6G* Ivy Gold Vinyl
2K,6K* Aqua Vinyl
2U,6U* Parchment Vinyl
2Y,6Y* Nugget Gold Vinyl
7A,5A* Black Comfortweave
7B,5B* Blue Comfortweave
7D,5D* Red Comfortweave
8A,9A* Black Comfortweave-Bench
8B,9B* Blue Comfortweave-Bench
8D,9D* Red Comfortweave-Bench
8U,9U* Parchment Comfortweave-Bench
8U,5U* Parchment Comfortweave

*Decor Group

1969 INTERIOR TRIM

CODE TRIM DESIGN
1A Black, Cloth/Vinyl-Luxury
1B Blue, Cloth/Vinyl-Luxury
1G Ivy Gold, Cloth/Vinyl-Luxury
1Y Nugget Gold, Cloth/Vinyl-Luxury
2A Black Vinyl
2B Blue Vinyl
2D Red Vinyl
2G Ivy Gold Vinyl
2Y Nugget Gold Vinyl
3A Black Knitted Vinyl-Mach 1
3D Red Knitted Vinyl-Mach 1
3W White Knitted Vinyl-Mach 1
4A,DA* Black Comfortweave, High-Back Buckets
4D,DD* Red Comfortweave, High-Back Buckets
4W,DW* White Comfortweave, High-Back Buckets
5A Black Comfortweave-Luxury
5B Blue Comfortweave-Luxury
5D Red Comfortweave-Luxury
5G Ivy Gold Comfortweave-Luxury
5W White Comfortweave-Luxury
5Y Nugget Gold Comfortweave-Luxury
7A Black Convertible Deluxe Buckets
7B Blue Convertible Deluxe Buckets
7D Red Convertible Deluxe Buckets
7G Ivy Gold Convertible Deluxe Buckets
7W White Convertible Deluxe Buckets
7Y Nugget Gold Convertible Deluxe Buckets
8A,9A* Black Comfortweave-Bench Seat
8B,9B* Blue Comfortweave-Bench Seat
8D,9D* Red Comfortweave-Bench Seat
8Y,9Y* Nugget Gold Comfortweave-Bench Seat

*Decor Group

1970 INTERIOR TRIM

CODE TRIM DESIGN
AA Black, Houndstooth Cloth & Vinyl
AB Blue, Houndstooth Cloth & Vinyl
AE Vermillion, Houndstooth Cloth & Vinyl
AF Ginger, Houndstooth Cloth & Vinyl
AG Ivy, Houndstooth Cloth & Vinyl
BA Black Vinyl
BB Blue Vinyl

Continued on page 41

FORD POWER

SUBSCRIBE TODAY!

ONLY \$19.00 PER YEAR (12 Issues)

FIRST CLASS: \$38.00 per year

SUBSCRIPTIONS OUTSIDE U.S.A.

(all prices at U.S. exchange)

Canada and Mexico: \$33 (Air Mail \$38.00) per year; All other foreign subscriptions: Air Mail - \$48.00 per year.

SEND CHECK OR MONEY ORDER TO:

SUPER FORD

188 Ovid Street, Seneca Falls, NY 13148

OR

Now you can use your Master Card or Visa to subscribe. Just complete the form below right and mail it in. In a hurry? For immediate service, call **SUPER FORD** between 9 a.m. and 4 p.m. weekdays, with the information on your Master Card or Visa card. (315) 568-2011.



IMPORTANT: COPY ACCOUNT NUMBER FROM YOUR BANKAMERICARD VISA

MY CARD EXPIRES

IMPORTANT: COPY ACCOUNT NUMBER FROM YOUR MASTERCHARGE

COPY NUMBER ABOVE YOUR NAME ON MASTER CHARGE

MY CARD EXPIRES

Name _____

(AS IT APPEARS ON CHARGE CARD)

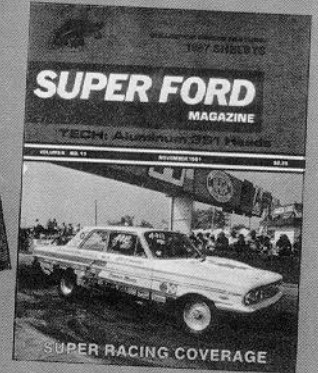
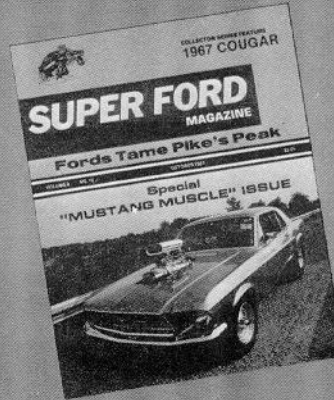

The #1 all Ford and Mercury magazine bringing you monthly columns like:

Horsensense, Competition Hotline, Tech Line, Ed Derry's Street Rod Corner, NASCAR Fords, Ford News Update, Tip of the Month, Ford Facts and Feats, Super Ford Collector Series, Letters to the Editor, Book Report, The Boss Mustang Corral, Coming Events, Ford & Mercury Club reports, Mean Machine, Engine Articles . . .

and our giant advertising section gives you all Ford and Mercury classified and display advertising from throughout the United States and 18 foreign countries!

We are an aggressive publication that combines history from Fords in the past, news of Fords in the present, and what Ford has planned for your future. **SUPER FORD MAGAZINE** encompasses the full spectrum from racing to restoration while providing you a monthly smorgasFORD of cars, parts, literature, and services, in the comfort of your own home.

DON'T DELAY! If you're into Fords and Mercurys, this is the complete Ford magazine you've been waiting for!

Name _____ PLEASE TYPE, OR PRINT CLEARLY

Address _____

City _____

State _____ Zip _____

Phone _____

New Renewal / Expires _____

SUPER FORD

MAGAZINE

Baton Rouge Beauty

by Bobby Spedale





Rare Mustangs are very scarce down in Baton Rouge. My present car came from Houston, Texas, where I purchased it in September, 1978.

The car is a 1972 blue convertible with blue interior and white top. It was originally equipped with the normal one-color paint with the chrome rocker panel. Since then, the rocker panel has been removed and a new blue metallic iron paint has been taken on. New chrome was taken on where needed, then I added the Mach I stripes, and the all lower panels were painted silver along with the NASA type hood. A set of Magnum 500, Radial T/A's, front spoiler and factory dual exhaust with cut out rear panel and Ford tips were all added which really give the car its total appearance.

The car is powered by a 351-2V Cleveland motor. Other options consist of RAM-AIR package, automatic, hood locks, racing mirrors, power steering, power brakes, full console with clock, air conditioning, and, of course, power top. Future plans call for the installation of a tilt steering wheel and complete stereo system. The car is driven daily and many compliments and offers have been received. I am proud to be the owner of this really classic Mustang.



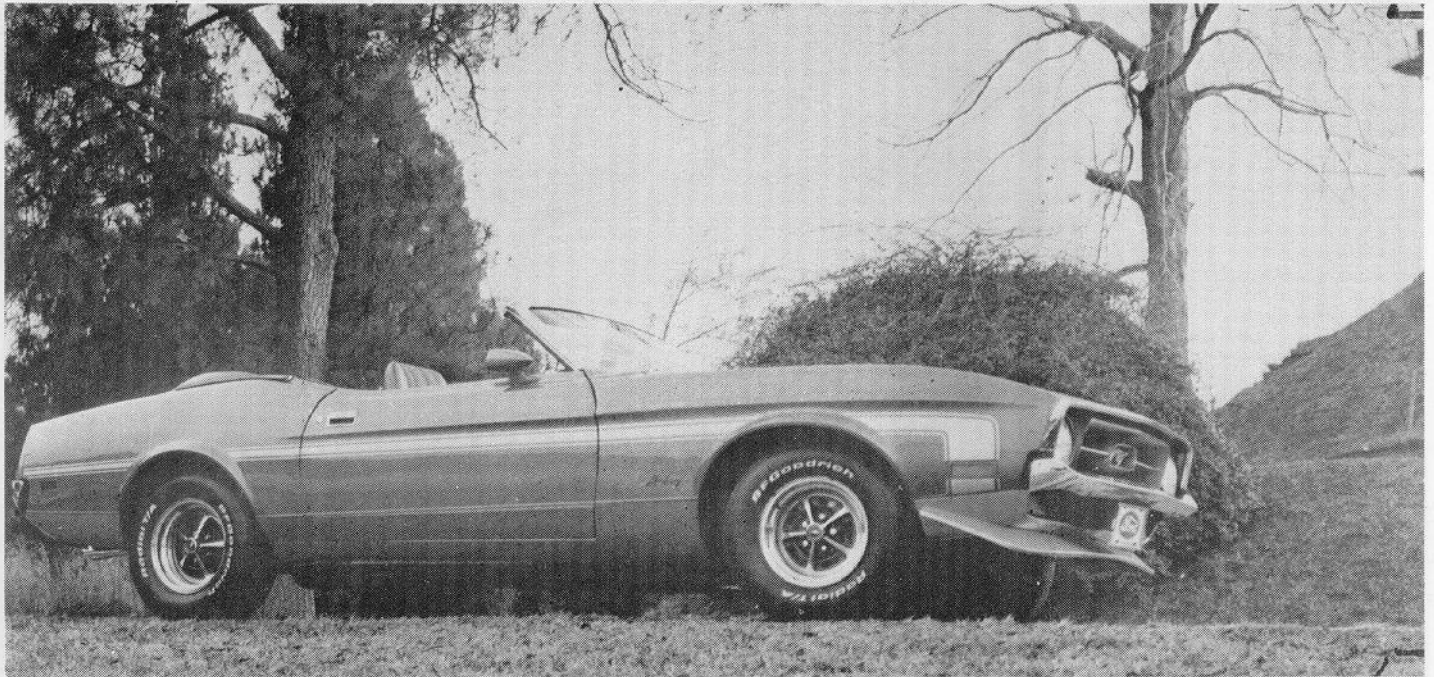

**Recent Addition: License Plate
Reads "TOPLESS"**

Late News Bulletin: Bobby has recently sold this Mustang to Tim Seals, a good friend of his who helped him restore the convertible. Future plans for Bobby include a 1969 Shelby convertible.

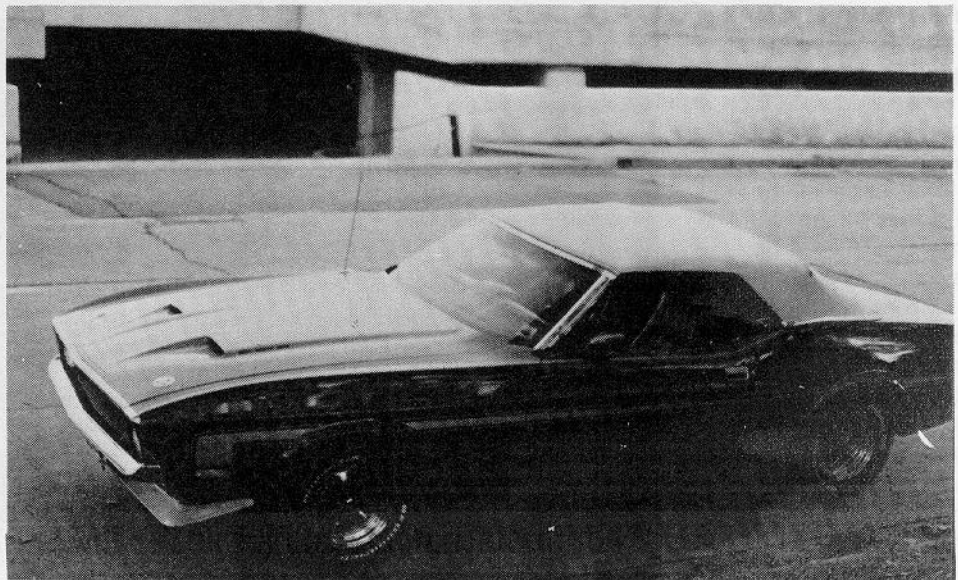

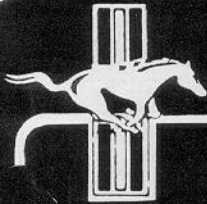

mr. mustang

**"Complete" Mustang Parts Store and
Frame-Up Restoration Facility.**

If you don't see
it listed here, call
anyway these are
just a few
examples of our
vast inventory.

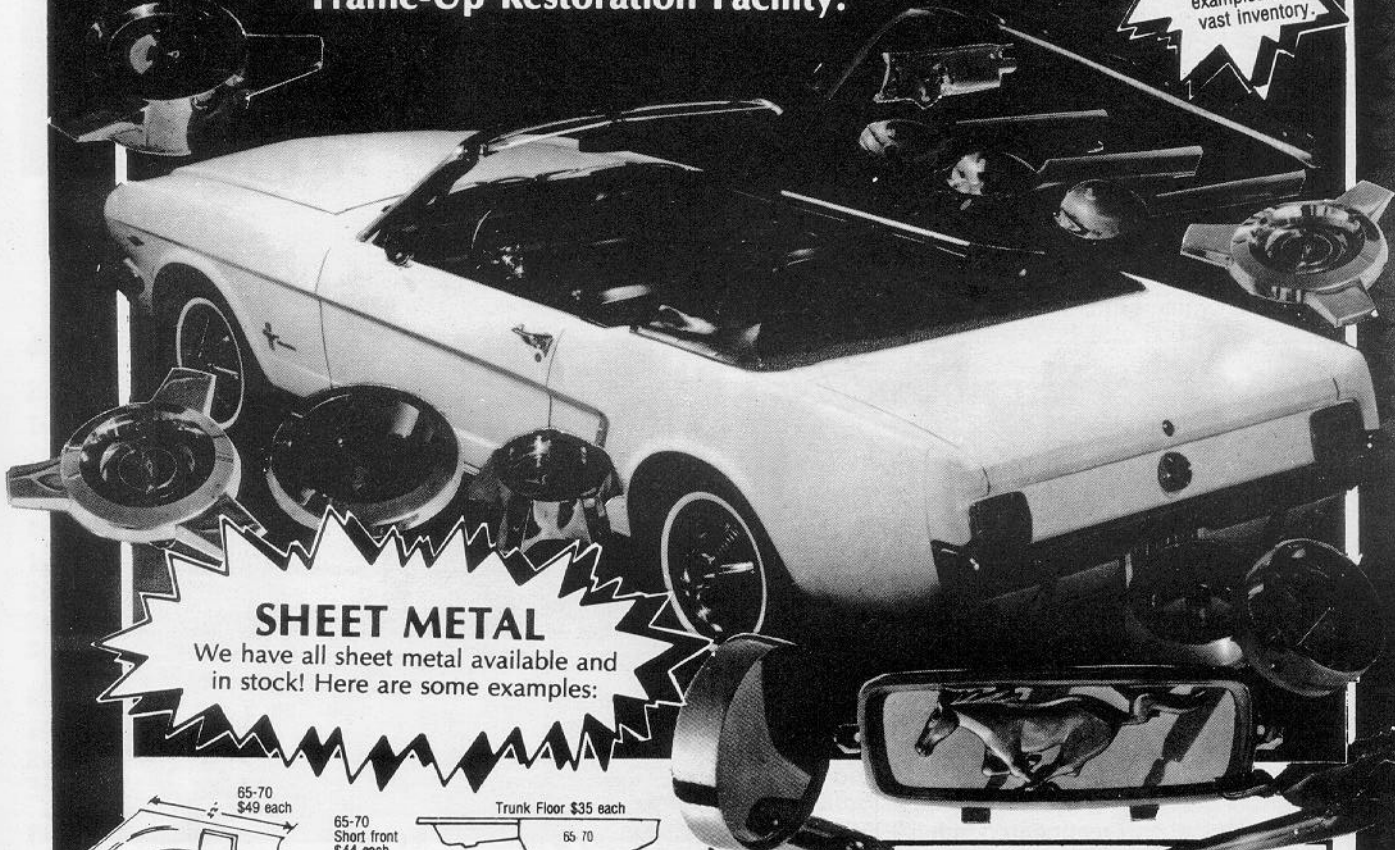

SHEET METAL

We have all sheet metal available and
in stock! Here are some examples:

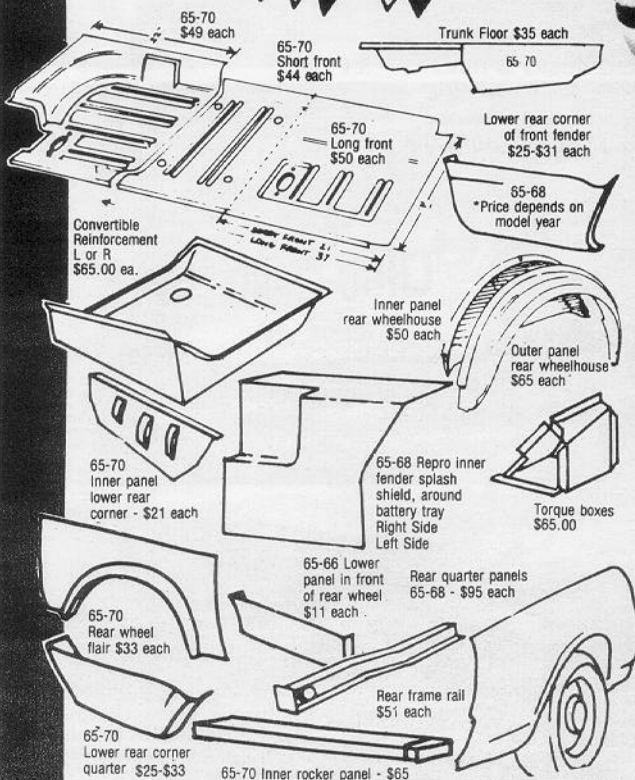

For Toll Free Orders Of

**\$25.00 or More Call (800) 543-9195 - Ohio Residents Call
(513) 275-7439. Send \$2 For Our Current Catalog**

- 65/66 Pony Corrals for front grilles available and in stock.
- 65/66 3 Pronged Wheel Spinners with blue centers . . . ea. **\$25.00**
- Set of 4 **\$98.00** w/o centers **\$20.00** ea. Centers alone **\$10.00** ea.
- 65/66 Styled Steel Wheel Centers, 2 1/2" complete . . . ea. **\$13.00**
- 65-70 Simulated wire wheel covers NOS ea. **\$85.00**
- 64 1/2/65 Wheel Cover Spinner & Center Cap ea. **\$25.00**
- 67-70 Wheel Cover Centers, complete ea. **\$20.00**
- 67 Styled Steel Wheel Center ea. **\$10.00**
- 65/66 Air Conditioning Bezels (set of 4) **\$24.95**
- 65/66 Convertible Hinge Bracket (rechromed) pr. exchg . **\$90.00**
- 65-70 Front or Rear Bumper Rechrome **\$90.00**
- 65/66 Right Hand non-remote mirror ea. **\$75.00**
- 65/66/67 GT Light Bars **\$100-\$125**
- 65-68 Luggage Rack **\$135-\$160**
- 65-67 Pony Door Panels - All Colors - State Year & Color (plus old panels) pr. **\$165.00**
- 65-68 Upholstery - Complete set **\$179-\$199**
- Pony - Complete set **\$239**
- 65-70 Molded Carpet (specify year & color) set **\$100**
- 65/66 Door edge guards pr. **\$24.95**
- 65/68 Kick Panels pr. **\$35.00**
- Convertible Top Chrome Trim - Right & Left exchg **\$75.00**
- Repr w/o exchg **\$75.00**

Specify year, body style and trim colors where applicable. All orders shipped UPS. Use your Master Charge, Visa, Check, Money Order or COD.

Mr. Mustang, 5088 Wolf Creek Pike, Dayton, Ohio 45426 (513) 275-7439

*a world of excitement and fun
hosted by the Scenic City Regional Group*

The 1982 World Mustang Expo Chattanooga, Tennessee

The 1982 World Mustang Expo promised a lot and delivered it all July 23, 24 and 25 in Chattanooga. The Scenic City Regional Club, spearheaded by John Henderson and Eddie Caheely, hosted the show, where 126 Mustangs were judged.

Headquarters for the show and site of the Awards Banquet was the famous Chattanooga Choo Choo Hilton Inn, an old railroad station that has been converted into a unique motel and family vacation center. Formal gardens, an indoor pool, railroad cars converted into motel rooms, and historical railroad displays were sidelight attractions for MCA members.

The real "action", however, was at the Jaycees' Fairgrounds, where the Mustangs were displayed and judged. Vendors offering a wide supply of Mustang goodies included Jim Osborn Reproductions, Mustang Custom, Auto Custom Carpet, Ohio Mustang Connection, Mr. Mustang, Mr. G's Mustang, Vintage-Tee's, Trophies, Inc. and many others.

According to all reports, the eatin' was unusually good at the 1982 World Mustang Expo. A delicious and plentiful barbecue dinner was offered Friday evening, and the Awards Dinner the following evening featured roast beef, two vegetables, salads, fruit cocktail and choice of fruit pies for dessert.

Following dinner and the excitement of the awards presentation, a large group gathered to enjoy dancing and listening to a live band that specialized in country and pop music. A highlight of the evening was the band's last set. The musicians left for a break and reappeared in full 1950's get-ups, complete with jeans, greasy hair and all the Sha-Na-Na stuff, and danced '50's style to their own music. MCA members joined in, and it was fun for all.

Although rain (apparently a regular Mustang bugaboo) hampered the activities of Friday afternoon and evening, those who attended the 1982 World Mustang Expo agree that it was one of the best MCA shows ever.

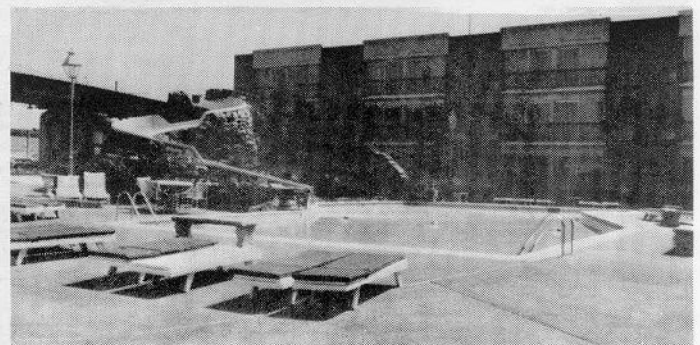
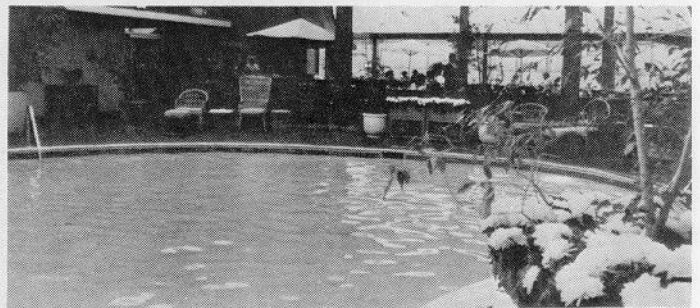
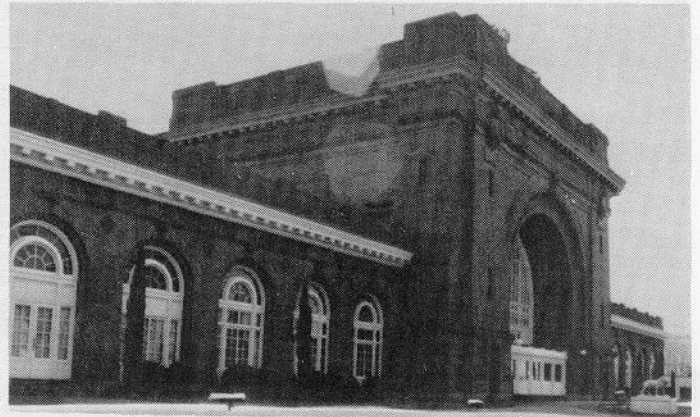

Chattanooga Choo Choo Hilton Inn Facilities

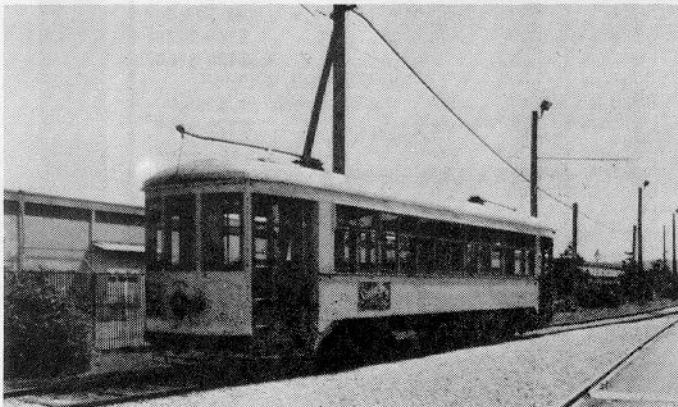

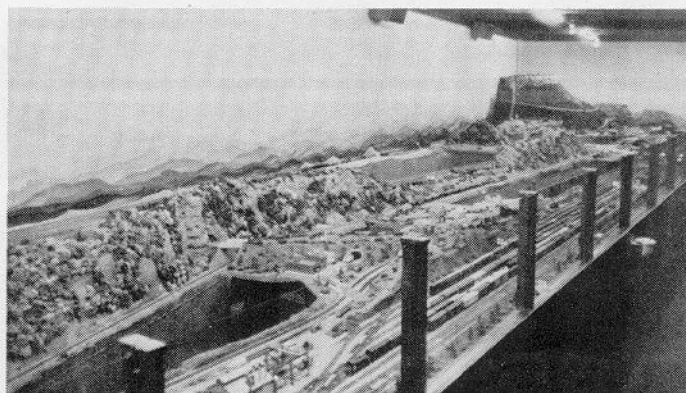

The Winners! 1982 World Mustang Expo

JUNIOR DIVISION WINNERS!

1964 1/2 - 1965 Coupe

- 1st John Hall
- 2nd Henry Green
- 3rd David Smith

1964 1/2 - 1965 Convertible

- 1st John Murphy
- 2nd Carroll Stillinger
- 2nd Howard Brown
- 3rd Mel Parks

1965 Fastback

- 1st Ed Jenkins
- 2nd Perry Blackwell
- 3rd Mack Huffaker

1966 Coupe

- 1st Jack Locke
- 2nd Jack Setzer
- 3rd Johnny Bishop

1966 Convertible

- 1st James Watters
- 2nd Mac McBryde
- 3rd Joe & Ann Stillinger
- 3rd Gary Walker

1966 Fastback

- 1st Eddie Caheely
- 2nd Tom Gattis
- 2nd Dale Taylor
- 3rd Gary Hartter

1967 - 1968 Coupe

- 1st William Siddons
- 2nd Mike Eidson
- 3rd John Durako

1967 - 1968 Convertible

- 1st William Craig
- 2nd John Aldridge
- 3rd Gary Hartter

1967 - 1968 Fastback

- 1st Donald Chandler

1969 - 1970 Fastback

- 1st Ronald Ward
- 2nd Raymond Heck
- 3rd James Howard

1971 - 1973 Coupe

- 1st Debbie Van Hook
- 2nd Richard Smither
- 3rd Eddie Caheely

1971 - 1973 Convertible

- 1st Billy Clayton
- 2nd Sonja Blackwood
- 3rd Gail Nunley

1971 - 1973 Fastback

- 1st Sam & Diane Barone
- 2nd Harry Kulp
- 3rd Joe Greer

1967 - 1970 Shelby

- 1st Gary Childress
- 2nd Randy Burdine
- 3rd Ron Sheets

Boss

- 1st Ronald Carrol
- 2nd Terry Greeson

Unrestored

- 1st Dan Schmidt
- 2nd Jim & Sue Osborn
- 3rd Bob Davis

Street Driven (-20)

- 1st Kevin Newton
- 2nd Randy Cunningham
- 3rd Sandra Spellman

Street Driven (20 +)

- 1st Robert Lee
- 2nd Garnett Wallace
- 3rd Jane Fussell
- 3rd Frankie Landers



John Hall's Coupe



Gary Childress' Shelby

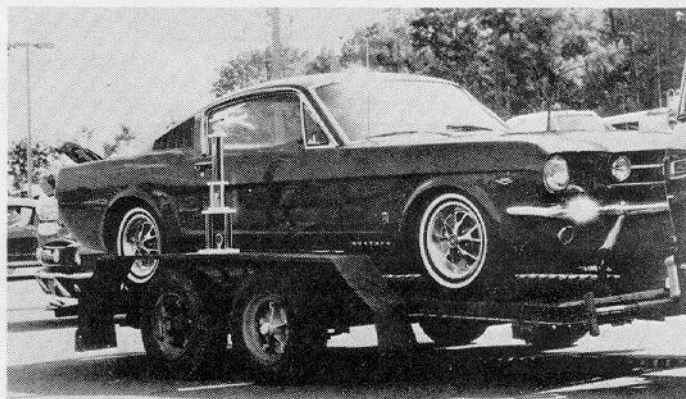

Tom Gattis' Fastback

The Winners! 1982 World Mustang Expo

Junior Modified Street

- 1st Ed Xiques
- 2nd Randy Alton
- 3rd Bob Kasprzak
- 3rd Micky Davis

Junior Modified Conservative

- 1st Mike Tankersley
- 2nd James Ladewig

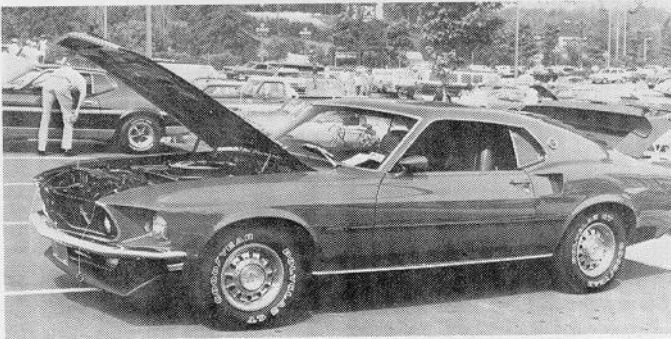

James Howard's 1969 MACH I



Mel Park's Convertible

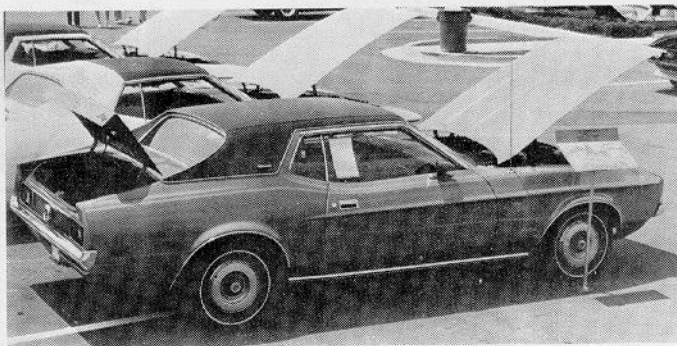

Dick Smithers' Grande

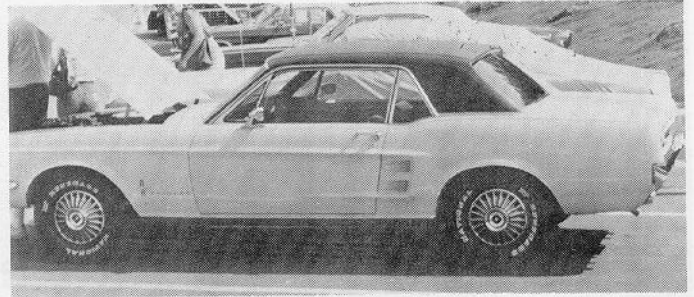

Billy Vaughan's Hardtop

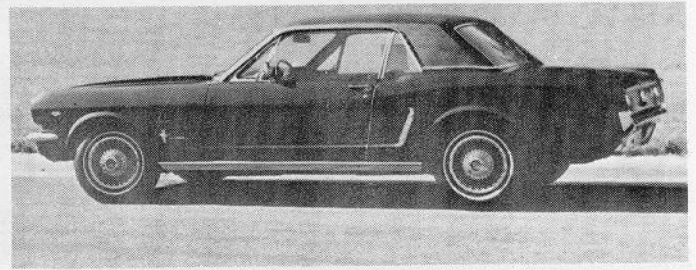

Ken Stange's "Ivy"

SENIOR DIVISION WINNERS!

1964 ½ - 1966 Coupe

- 1st Richard Wright
- 2nd Cecil Wilson

1964 ½ - 1966 Convertible

- 1st Sam Bright
- 2nd Walter Eubanks

1965 - 1966 Fastback

- 1st Betty Cox

1967 - 1968 Coupe

- 1st J. W. Gowin

1967 - 1968 Convertible

- 1st J. W. Gowin
- 2nd Perry Rivers

1967 - 1968 Fastback

- 1st Alan Spradlin

1969 - 1970 Coupe

- 1st Floyd Scranton

1969 - 1970 Fastback

- 1st Charles Breeden

1971 - 1973 Coupe

- 1st David McCaleb

1971 - 1973 Fastback

- 1st Teresa Vickery

Boss

- 1st Billy Davis

Senior Modified Conservative

1st Ralph Smith

Senior Modified Radical

1st Jim Farlow

JUNIOR DIVISION

Best of Show Stock

Junior Downer
Jeff Murr

Best of Show Modified

Larry Rummage

SENIOR DIVISION

Best of Show Stock

Jim Baker

Best of Show Modified

Ernie Stout

Model Cars

1st Troy Watts
2nd Mack Landers
3rd Joey Farlow



Ralph Smith's Modified Convertible

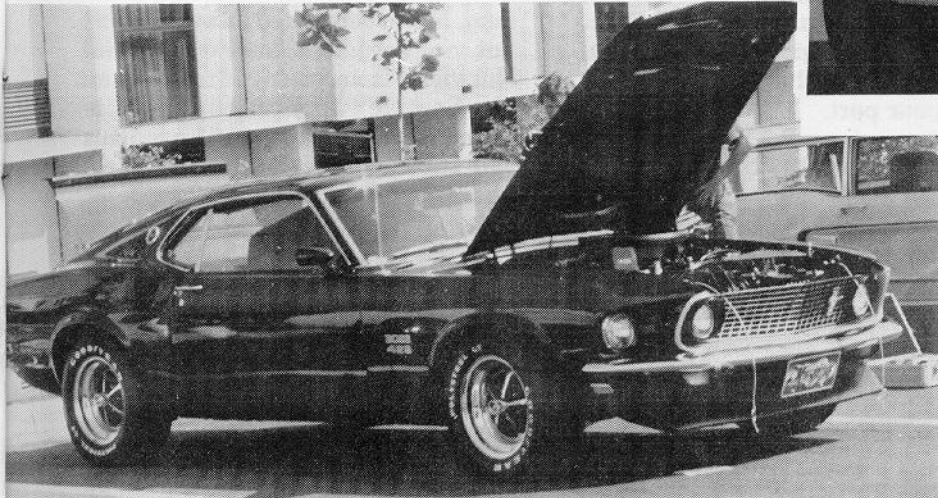

Billy Davis' Boss 429



Ernie Stout's Wagon



Jim Farlow's Pick-Up

IN SEARCH OF MUSTANGS

I would again like to spend this month thanking those who care about this project! I would like to start with Richard Gerardis and Dolores Oertel of New Jersey for another surplus of VID information that they submitted to "In Search." Richard and Dolores both have submitted a lot of information in the past, and once again we are blessed with their enthusiasm. Richard and Dolores, I thank you both very much.

Another fine individual is Fred Glazier. (You guessed it, of Glazier's Mustang Barn.) Not only is Fred a fine man to deal with for your Mustang parts and accessories, not to mention restoration, Fred was also kind enough to submit VID information from the First Pennsylvania Regional Group. They ran an "In Search of Mustangs" application in their Newsletter, and the response was quite impressive. Fred, from the bottom of my heart, I want to thank

you! Now, if only other MCA regional groups could do the same. Can I count on the rest of you to help "In Search" grow? We are just under the 4,000 mark.

"In Search of Mustangs" can be a family affair, as well. Larry Hernandez of California submitted information on his 1964½ Mustang — 5R07F103043 Built 29 July 64. His sister has submitted two 64½ Mustangs to the registry in the past. Larry, I want to thank you both for doing your part.

Among unique Ponies submitted, we have a 1972 MACH I, 2F05R208900, built in May, 1972. The MACH I has the rather rare 351 High Output Cleveland. Not many 72's were blessed with this powerplant. This MACH I has a DSO of 17 showing delivery new to the Washington, D.C. area. Its owner is David Bye of New Jersey. The 351 H.O. for 72 wasn't as wild as the

BOSS 351 for 71, but as government controls tightened in 72, the performance days faded into the past. 1972 was truly the last year for an even vaguely strong Mustang. There are a few 1973 Ponies tooling about that maintain the performance image, though.

A nice letter from Marie Finnell of Florida asks about her 1967 Mustang. Marie submitted just the codes, but no Vehicle Warranty /Serial Number. Marie, you need to fill out an "In Search" application, found in recent issues of Mustang Times. This will show you just what we need. Thank you, Marie, for writing.

Another nice letter from Stephen Franklin of California. Stephen sent in information on his 1968 Mustang Hardtop 8R01C120740 Built 28 Dec. 67 at the San Jose, California plant. Stephen is living proof of how much most of us love our Mustangs. Under "Options You Added," Stephen put "LOVE". That is truly the best option you can put on your Mustang. In all reality, "LOVE" is standard equipment on most Mustangs!

One thing I have noticed about many of you who have participated is the warmth and enthusiasm you radiate in your letters. Many letters end with "Mustangs Forever," "I LOVE MUSTANGS," "I LOVE MY MUSTANG," "I WOULDN'T SELL HER FOR ANYTHING!" just to name a few! It is very obvious just how much we all love this addiction called "Mustang Fever."

I would like to thank Keith Blanchard of California for the VID information that he submitted to "In Search." Keith submitted seven Mustangs to the project. A couple of these Mustangs are junked. This gives you an idea of what we are looking for — junked Mustangs, mint Mustangs, restored Mustangs, average Mustangs, not to mention the unique ones! It is up to YOU to find them!

In answer to Tim Nagao of California on his 1966 Mustang 6R07C162731 built on February 7, 1966 at San Jose, California. Tim's Mustang was delivered new to the Los Angeles area with a DSO of 71. Thank you, Tim, for writing.

Another interesting letter has a

Catalog \$2.00

Mustang of Chicago™



WE CARRY A COMPLETE LINE OF ---

- 65 thru 72 73 Mustang parts
- 65 thru 70 Shelby parts
- 32 thru 56 Ford parts

DIVISION OF
DELUXE FORD PARTS LTD.
2 south ADDISON St.(rear) BENSENVILLE, IL 60106
(312) 860-7077

"IN SEARCH OF MUSTANGS"

Participate today in "IN SEARCH OF MUSTANGS," an international register of Ford Mustangs and Shelby Mustangs from 1964½ through 1973. What we need is as simple as fill in the blanks! The information can be found on a metal plate (1964½-69) or vinyl sticker (1970-73), found on your driver's door near the latch. If there is no plate or sticker, just the serial number is adequate. Total information is very important. Feel free to enclose history on your Mustang, every Pony has it's own story. Don't forget those junkyard Mustangs; they need to be counted, too.

Name _____ City _____ State _____

1. Year _____ Is it a GT, MACH I, GRANDE', California Special, T-5 etc? _____

Options _____

Original Driveline? _____ Do you wish your name printed? _____

Warranty/Serial Number _____

Body _____ Color _____ Trim _____ Date _____ DSO _____ Axle _____ Trans _____

2. Year _____ Is it a GT, MACH I, GRANDE', California Special, T-5 etc? _____

Options _____

Original Driveline? _____ Do you wish your name printed? _____

Warranty/Serial Number _____

Body _____ Color _____ Trim _____ Date _____ DSO _____ Axle _____ Trans _____

3. Year _____ Is it a GT, MACH I, GRANDE', California Special, T-5 etc? _____

Options _____

Original Driveline? _____ Do you wish your name printed? _____

Warranty/Serial Number _____

Body _____ Color _____ Trim _____ Date _____ DSO _____ Axle _____ Trans _____

Thank you for participating in "IN SEARCH OF MUSTANGS". Please send all information to Jim Smart, P.O. Box 342, Salisbury, MD 21801-0342. A self addressed stamped envelope will get you a reply!

story with it. Charlie Patterson of California has a 1968 Mustang 8R01C143076 Built 16 February 1968 at the San Jose Plant. It has a DSO of 710784, showing delivery to the L.A. area and was a special order Mustang! Special order because of the extra four digits after the DSO of 71. Charlie's Mustang has no color code. This Mustang may have a special color as Charlie says it is too green to be aqua, but too aqua to be light green! This Mustang has the original paint. Can anyone explain this one? Charlie, my advice to you is to find your production manifest (computer printout). If you have no luck there, you may wish to visit an automotive paint supplier. Ask your Ford dealer about colors available on Fords other than Mustangs in 1968. Some Mustangs could be ordered with Thunderbird colors as an option

in certain years. My advice is to try to go with that color when you paint her; it obviously was a special option and quite rare. Good luck, Charlie, in your search!

Another nice letter from Greg and Fred Wong of Ontario, Canada contains two BOSS Mustangs. A 1970 BOSS 302, OT02G113724 with a DSO of B1, showing delivery new to Eastern Canada. The other BOSS, a 1971 BOSS 351, 1F02R142949 built in October 1970 with a DSO of B1 meaning Eastern Canada. Both Mustangs have been modified some. Thank you, Greg and Fred, for adding these two limited production Mustangs to our registry!

Heather Adam of New York tells us about her five year dream come true! 8T02J149254 — 01053, a 1968 Shelby GT 350! Heather picked this gem up for (check your eyes) \$5,000,

and it is in suprisingly good condition! This Shelby left the Metuchen, N.J. assembly line on January 11, 1968. I would like to thank Heather for submitting her Cobra /pony to our registry!

I would like to thank Teresa Vickery for her tremendous help on this project. Teresa took the time to place "In Search" applications in each registration packet at the Eastern National. Applications also found their way to vendors and Mustangs for sale in the Pony Corral. I encourage all of you who participated in the Eastern National to please send in your application.

Larry Nash of Pennsylvania wants to know if his 73 convertible (3F03H220960 built in April 1973) is the last one built. Well, Larry, your 73 Mustang is not the last convertible built, but 1973 was the last year for a

Mustang convertible. For everyone's information, the last Mustang convertible was 3F03Q259417 built on June 25, 1973. This Mustang, as of 1978, had still not been titled and has few miles on it. The owner is Ron Stoltz of Pennsylvania, a former Ford dealer. Mr. Stoltz has had this Mustang since new, and it is not only the last Mustang convertible, but also the last convertible built by Ford Motor Company!

Finally, I would like to make it known of the availability of IN SEARCH OF MUSTANGS T-Shirts! If you desire these T-Shirts, please contact me as soon as possible. The shirts are \$6.50 each. In wearing your IN SEARCH OF MUSTANGS T-Shirt, you will help spread the word.

I would like to ask "Mustang Andy" of Utah if he intends to participate in "In Search." Mustang Andy wrote to me some time ago telling me about some 80 Mustangs he has in his inventory, but did not have the time to jot it all down. Would anyone in the Ogden, Utah area like to help Mustang Andy?

See you at the Grand Nationals!!

Jim Smart

Tom Horne REPRODUCTIONS

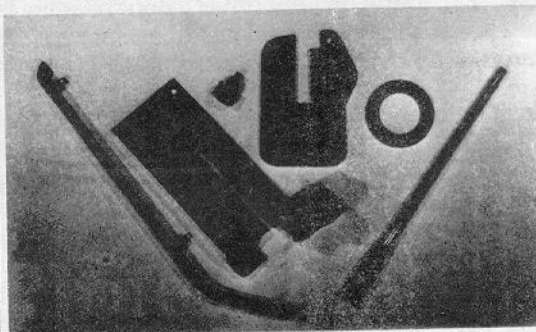

NEW MUSTANG REPRODUCTION PARTS

- 1967-68 Rear bumper guard rubber pads each \$5.95
- 1967-68 Front bumper guard rubber pads each \$8.25
- 1965-68 Original style rubber sun visor tips pair \$1.95
- 1965-66 Door to window rubber seal pair \$10.95
- 1965-66 Quarter pillar to window rubber seal pair \$10.95
- 1965-68 Floor dimmer switch accessory rubber trim cap each .75
- 1965-68 Trunk or rear deck lid rubber bumpers each .95
- 1965-68 Round base antenna rubber pad, EXACT REPRODUCTION (not Ford replacement type) each \$1.00
- 1965-66 Turn signal switch lever each \$8.95
- 1965-66 Metal brake pedal trim (automatic transmission) each \$4.00
- 1965-66 Inside mirror bracket, available June 30, 1982 each \$15.95
- 1965-66 Interior day/night rear view mirror available August 1, 1982 each \$29.95
- 1965-66 Firewall - hood seal each \$7.95
- 1967-68 Firewall - hood seal each \$8.95
- Foot windshield washer rubber pad each \$1.75

Please Add 10% Shipping • Call Or Write For Free Catalog

23032 HATTERAS STREET
WOODLAND HILLS, CA 91367
(213) 348-0332

MEMBERSHIP APPLICATION

THE MUSTANG CLUB OF AMERICA

Yes!! I want to join the most responsive and fastest growing organization in the world dedicated to the preservation, history, and enjoyment of the original ponycar, the 1964½-1973 Ford Mustang in all its shapes and styles, years and models. Enclosed is \$20 for US or Canada member of \$40 for foreign member (US funds only in all cases). Dues include \$15 for twelve monthly issues of the *Mustang Times*. Please send my new member's packet immediately and also send the first of my twelve issues of the *Mustang Times* as soon as possible.

**send to: Mustang Club of America,
P.O. Box 447, Lithonia, Georgia 30058**

name _____ spouse _____

address _____

city, state, zip code _____

cars owned _____

if regional group member, which? _____

OWNERSHIP NOT ESSENTIAL — ENTHUSIASM IS!

New Mustang Styled Steel Wheels



The Ultimate Accessory For All . . .
1965, 1966 & 1967 V8 MUSTANGS

- U.S.A. manufactured
- Show quality chrome finish
- Correct rim widths
- Proper gray insert color
- Meets S.A.E. test requirements
- Mustang Club of America concourse approved
- Guaranteed, beautiful, and authentic!

SUGGESTED LIST PRICE

1965 Wheels (4) \$465.00 • 1966 Wheels (4) \$395.00 • 1967 Wheels (4) \$395.00
(Caps, Lugs & Trim Rings Extra.)

**FOR WHEELS AND WHEEL ACCESSORIES
SEE YOUR LOCAL MUSTANG PARTS SUPPLIER OR CONTACT US DIRECT:
VINTAGE MOTORS, INCORPORATED,
131 Arthur, Des Moines, Iowa 50313 (515) 274-4540**

Mid America

MUSTANG PARTS

NOW OPEN

UPHOLSTERY

Most authentic Mustang upholstery available.

STANDARD SETS 1965-68

Two buckets & rear seat	\$189.95
Two buckets	134.95
One bucket	69.95

PONY SETS 1965-66

Two buckets & rear seat	244.95
Two front buckets	159.95
One bucket	89.95

FRONT SEAT CUSHION BUNS Pony or Standard

Two front buckets	99.50
One bucket	50.00

STANDARD DOOR PANELS

1965-67 Original colors available	pr. 99.50
-----------------------------------	-----------

ARM REST PADS

65-66 Specify color	15.35
---------------------	-------

ARM REST BASE

65-66	14.10
-------	-------

DASH PADS

65-66 Black, Blue and Red	135.20
---------------------------	--------

DASH INSTRUMENT BEZEL

'65 w/warning lights	25.25
'65-66 woodgrain (use w/gauges)	25.25
'66 Chrome w/Black camera finish	25.25

DASH BEZEL LENSE

65 Bezel lense (warning lights)	16.90
65-66 Bezel lense (with gauges)	14.00

KICK PANELS

65-66 All body styles all colors	27.00
----------------------------------	-------

HEADLINERS

1965-1970 Coupe or Fastback Moonskin Grain Vinyl	35.95
--	-------

VINYL SNAP ON WINDLACE

Specify color	ft. 65'
---------------	---------

CONVERTIBLE TOPS

1965-1970 Black or White	110.00
--------------------------	--------

CONVERTIBLE TOP BOOTS

All colors	39.95
------------	-------

CONVERTIBLE TOP PADS

Set of two	19.00
------------	-------

CONVERTIBLE WELL LINER

65-66 White or Black	19.95
67-70 White or Black	19.95

QUARTER TRIM UPHOLSTERY

Convertible all colors	pr. 39.00
------------------------	-----------

TRUNK MATS

1965-68 Coupe or Convertible plaid design like orig.	19.95
1965-68 Fastback, plaid design like orig.	19.95

TIRE COVER Plaid design	12.50
-------------------------	-------

ORDERING INSTRUCTIONS

- Visa or MasterCard
- Arkansas residents add 3% sales tax
- Exact Freight charges on orders under \$150.00
- Prepaid over \$150.00
- Usually same day shipment UPS
- COD shipments
- Please specify color, make, year & model

MOLDED CARPET 1964 1/2-70

Top of the line, best available. Easy installation.	
Coupe & convertible	99.50
Fastback w/ fold down	112.00

RUBBER FLOOR MATS

Mustang floor mats w/running horse. Black w/red, white, blue comp. Set of 4	38.95
Reproduction of the Mustang "Running Horse" rubber floor mat. Available colors are black, blue, white, red and green	38.95

HARDWARE

EXTERIOR TRIM SCREW KIT

Stainless (all models)	15.00
------------------------	-------

INTERIOR TRIM SCREW KIT (All models)

	10.00
--	-------

BUMPER BOLT KIT, Front & rear

	10.00
--	-------

CONVERTIBLE BOOT SNAP STUDS (Kit of 17)

	12.50
--	-------

DOOR HINGES

65-66 Lower - Specify RH or LH	21.70
65-66 Upper - Specify RH or LH	21.70

WINDOW REGULATORS

65-66 Front door window regulator. Specify RH or LH	36.65
---	-------

VALVE COVERS

65-68 COBRA Small block valve covers 289-302	ea. 38.35
--	-----------

STEERING WHEEL

65-66	68.95
67	70.80

EMERGENCY BRAKE HANDLE

65-66	4.85-67-68	4.85
-------	------------	------

FAN SHROUD KIT (Includes screws & all brackets)

65-66	29.95
-------	-------

FUEL TANK - 65-68

	86.25
--	-------

SILL PLATES

65-68 Upper sill molding	ea. 12.95
65-68 Lower sill molding (accessory)	ea. 21.20

MOLDING

65-66 Bucket seat side molding	ea. 10.65
--------------------------------	-----------

AUTOMATIC TRANSMISSION SHIFT SEAL

(Rubber with correct metal insert, like original)	3.95
---	------



MUSTANG PARTS

11125 Arcade, Suite E
Little Rock, Arkansas 72212

1-501-225-1127

1-800-643-5491

9 to 5 Mon.-Fri. 9-12 Sat.

Prices Subject To Change Without Notice



Free Catalog — Call or Write Today!
Order Toll Free 1-800-643-5491



MUFFLER PUZZLER

John W. Pace

The above picture shows a muffler hanger, the right side to be exact, and it came from my 1965 Mustang Coupe.

That's right, my 1965 Mustang Coupe!

It all started this way. I was cleaning the underside of the car and when I got to the hangers, I unbolted them and put them aside for later cleaning or replacing.

One day in the mail came a Mustang parts catalog from Larry's Mustang Parts. Listed within was the muffler installation kit for a single exhaust V8. I immediately ordered this kit.

In about three weeks, the package arrived. I checked the order and sensed an error in one of the hangers. I went and got mine. The left one was correct. Could it be Larry's, or mine?

I placed a telephone call to Larry's and explained my problem to Tom. He looked up the hanger and told me what

was listed in their catalog and what, according to their supplier, was correct. Tom suggested that maybe the previous owner had had a different type hanger installed.

I checked this thoroughly. The plate where the three hole angle bolts through is spot welded to the frame. There is no visible welding around the edge of the plate. As far as I know, my muffler hanger is correct.

Now for the research part, I checked the final edition of Ford's Master

Catalog. Nothing. I then checked the 1965 Mustang repair manual. Nothing. My last source was a Ford Ready Reference Catalog published in 1966. Though it showed dozens of different hangers, not one was like mine.

I have since made my hanger almost good as new by drilling out the two large rivets and replacing the wornout tire cord with new. Instead of rivets, I used two $\frac{3}{8}$ " x 1" bolts. By painting the metal parts, the hanger could pass for a new one.

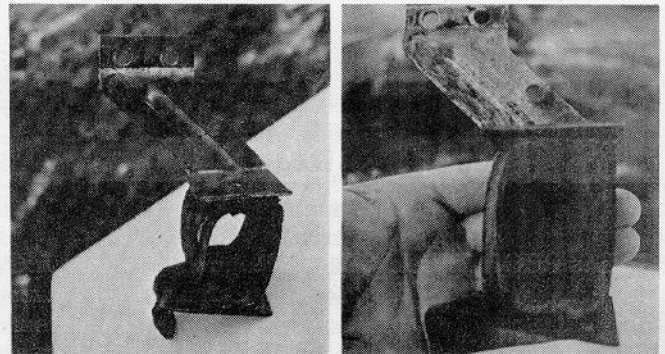

1969/70 MUSTANG FASTBACK DECKLIDS!

BRAND NEW ORIGINALS COMPLETE WITH WEATHERSTRIP & LATCH.

ONLY \$69.95 EACH

(Shipped U.P.S. C.O.D. for freight)

1st orders may have choice of 11 original colors. You can't repair your old trunk lid rust or damage as cheap as these are. Obsolete from Ford for several years — original list price was \$170.00! These have been in storage for over 10 years and have some minor scratches/dings, but you'll never find a better price! Buy a spare now, or wish that you did 5 years from now!

ORIGINAL "AUTOLITE" SCRIPT CHROME OIL BREATHER CAPS

Brand new rare pieces for the picky Mustang enthusiast!

Two types of caps: Push on hose connector tube on side, and Boss & CJ type with opening on top for hose. Your choice only \$10.00 each while supply lasts.

Send check/money order or call
VISA/masterCard to:

VINTAGE MOTORS, INC.
131 Arthur
Des Moines, Iowa 50310
(515) 274-4540

OHIO MUSTANG CONNECTION



YOUR ONE STOP RESTORATION FACILITY!

Columbus Area's Oldest & Largest Mustang Dealers
10 YEARS EXPERIENCE

SOFT TRIM and UPHOLSTERY —
ORIGINAL MOLDED CARPETS —
GENUINE FORD PARTS —
WEATHER STRIPPING —
LITERATURE —
SHEET METAL —
PONY MATS —
ACCESSORY —
EMBLEMS —
DECALS —

COMPLETE MUSTANG PARTS SOURCE
USED • NEW • REPRO.
MUSTANGS BOUGHT AND SOLD

We ship UPS — COD
Visa/masterCard Welcome

12981 NATIONAL RD. SW
PATASKALA, OHIO 43062
COLUMBUS, OHIO AREA

(614) 927-6078

REGIONAL GROUP NEWS

Valley Forge Regional Club

Thirty-three hearty Mustang lovers turned their steeds loose to roam on the fields at the Ridley Creek State Park in Edgemont, Pa. when the Valley Forge Regional Club of the MCA held their first July outing. Mostly fastbacks turned out under the threatening skies, but two convertibles went topless to bring the total number of ponies to 14.

As a warmup to the fall National, Clem Arlinghaus was gracious enough to let President Dick Matthews give his 66 2+2 the once-over in a preview of the September showdown at King of Prussia. Dick Lynn walked off with a Ford cleanup kit as a door prize. With no meeting set for August or September, everyone returned home to get prepared for the National.

New members present at the picnic were Pat and Donnie Cannon and Chuck and Ray Russo.

Jim Aberts
Corresponding Secretary

First Pennsylvania Mustang Club

Since First Pennsylvania has always considered the family an important part of our activities, we try to hold our summer meetings out-of-doors and on a Sunday.

The July meeting was held on the 11th at the home of President Bill Bollman and his wife, Ginny.

In spite of car shows in the area and summer vacations, we had 20 members and some of their children in attendance.

Work goes on for the two Car Shows that we are sponsoring. All the details are worked out, and it is just a matter of waiting for registrations.

Our local Coopersburg Show will feature a drawing for all pre-registered cars and vendors. We will be raffling off a Color TV and an AM-FM radio.

Looking forward to seeing all the vacationers traveling to our other show, The Liberty Bell Grand National. Have a safe journey to Philadelphia!

Linda Bowes
Secretary

Music City Regional

Music City Mustang Club became incorporated under nonprofit status with the State of Tennessee in April. We are very excited that our club has grown so much in such a short period of time (barely two years), with close to 100 members in our group at this time.

The Second Annual Music City Mustang Round-Up on May 15 was quite an event. Many thanks to those Mustangers who traveled to Nashville for our show. Despite some rain clouds (which, of course, seem to follow our Mustangs) and a brief shower of rain, I think everyone had a great time.

Becky Brumfield
Secretary

South Jersey Regional

The July 1 meeting showed eighteen members and five guests present. Minutes were read and approved by all members. Tee-Shirts and hats were distributed. The main topic of discussion was the September 12 Second Annual South Jersey Regional Mustang Club Car Show which will be held at the Millville Municipal Airport.

This month's 50-50 was won by Fred Alsop.

The August 5 meeting showed 25 members in attendance. The first order of business was the July 10 Ford Day at Rice & Holman Ford and Atco Raceway. There were thirty cars on display of which thirteen were club members. Tee shirts and belt buckles were given out to all participants. Two club members received trophies. First place for Best 65-68 went to Mark Pavel with his 1968 1/2 428 Cobra Jet, and a second place trophy went to Rick Riley with his 1970 428 MACH I in the class of Best 69-73.

Later that evening, the club members caravanned to Atco Raceway for a night of racing. There was also a show with approximately twenty cars. Out of eleven different classes, six members received trophies, as follows: Best 66 Mustang went to Henry McKee; Best 67 Mustang went to Barry Gruccio; Best 68 Mustang went to Mark Pavel; Best 70 Mustang went to Rick Riley; Best Boss Mustang went to Don berenato; Best of Show went to Mark Pavel.

The South Jersey Regional Mustang Club would like to thank all those who attended, and a special thanks to Rice & Holman Ford and Atco Dragway.

Charles R. VanLeuven
Newsletter Editor

Shenandoah Valley Mustang Club

We had a good car show at Hortons recently and had a nice turnout until the rains came. We have a lot of activities coming up in the next couple of months and we need you all there! We had a big car show at Berkley Plaza in Martinsburg, W.Va. July 31, and a car show on the Loudoun Street Mall August 28. The merchants in Strasburg, Virginia also want us to put on a show for them in September. The word is out and if we maintain our reputation, we will have more than enough to do.

Jim Biddle
Secretary-Treasurer

Highway Horsemen

I would like to express thanks to Steve and Hope Bilderain for their enthusiastic efforts in forming the HIGHWAY HORSEMEN, our Southern California Regional Group of the MCA. They have devoted so much time and effort stimulating interest and gathering members in what could be or probably will be one of the finest regional groups of the MCA. I believe

we're off to a good start; keep up the good work. Our meetings are held every second and fourth Thursday, 7:00 PM, at McCoy Mills Ford, 700 W. Commonwealth, Fullerton, California.

Keith Blanchard

Mississippi Coast Mustang Club

On July 11, we held our monthly meeting at the Western Sizzlin in Gulfport. We elected new officers for the coming year. They are president, Lamar Rhodes; vice-president, George McGee; treasurer, Mike Fitzpatrick; secretary, Elma L. Wilbanks; regional director, Jack Wilbanks. We also elected a twelve man Board of Directors and elected Vic McGee to be in charge of membership and new members. We plan to print a newsletter for members each month and to hold our meetings the second Sunday of the month at 2:00 at the Western Sizzlin.

Jack Wilbanks

Scenic City Regional Group

At our August meeting, our president, John Henderson, told everyone that he appreciated all they had done to help make our 1982 World Mustang Expo the success it was. There were very few complaints about the show, and everyone who participated seemed to enjoy it very much. Our outing for the month was a barbecue August 20 at 7:00 p.m. at Chickamauga Dam.

Mike Eidson
Secretary

Mustangs of Memphis

The Mustangs of Memphis Round Up took place June 26 at the Raleigh Springs Mall. This was the first big publicized show the Mustangs of Memphis has had since its founding in 1979. We are happy to say it was a success!

Mother Nature provided us with a hot but beautiful day which brought over seventy-five cars, ranging from a 64½ coupe to two 67 California Specials.

NOW AVAILABLE

1/25 Scale Die-Cast Miniature

THE 1965 MUSTANG is the original design with detailed 289 engine. Doors and hood open, seats fold forward.



Made from manufactures blueprints, and made big enough to show off all their fine details. Easy to take apart and details in your favorite colors.



Makes a perfect gift. Certain to be a collector item soon. Get yours now!!

We are now dealer for the **CONCOURS** upholstery kits. also have in stock all interior parts that are available from Ford.

We do interior and convertible top restoration by appointment only..

Send \$2.00 for parts list, refundable first order or free with car order.

\$16.95 ea. Lots of three or more \$15.00 ea. Please add \$1.00 ea. car for shipping and handling, TN resident add 6.75% tax.

TRI-CITIES SEWING SERVICES THE MALL

Johnson City, Tennessee 37601
Phone 282-6571

Mustang Parts & Interiors

We want to thank all of those sleepy-eyed members who set up the show site, helped with registration, classification, judging and the awards ceremony.

We also want to congratulate the following people on their winnings:

65 COUPE

1st Homer Harris
2nd Pat Schreurs
3rd Donn Lott

65 FASTBACK

1st Bill Blankenship
2nd Larry Connell
3rd Charles Young

65 CONVERTIBLE

1st Malcolm Stone
2nd Harrell Doty
3rd Roy McLain

66 COUPE

1st G.W. McNutt
2nd John Siron
3rd Zinn Everitt

66 FASTBACK

1st Al Stewart*
2nd Robert McNeal

66 CONVERTIBLE

1st Bill Cunningham
2nd Jerry Schreurs
3rd George Wallace

67-68 COUPE

1st Patsy Downer
2nd Donald Stout
3rd Andrea Cowart

67-68 FASTBACK

1st G.W. McNutt
2nd Mark Chenvoit

67-68 CONVERTIBLE

1st Tommy Durham
2nd Lee Shell
3rd Della Morris

Again we thank everyone who came and had a part in our first show.

*The Mustangs of Memphis want to extend our deepest sympathy to the family of Al Stewart. Al was a member of the MCA and recently became a member of the Mustangs of Memphis. Through a unfortunate accident, we lost Al. He wasn't with us long, but we admired and respected him greatly. We hope those members of the MCA who knew him will remember him and his family in their prayers.

Andrea Cowart
Secretary

Hernando County Mustang Association

We had three visitors at our July 10 meeting. Plans this month include putting a couple of our Mustang convertibles at Gary Brown Ford to help introduce the 1983 Mustang convertible.

Maryann Hall
Secretary

We had a nice turn out last month for our Gary Brown Ford sponsored Mustang car show. Mr. Brown has asked to sponsor a show every year for our club. Here are the results of the show:

DEALERS CHOICE

Sammy Joe Hall

CONVERTIBLE

1st Dick & Joan Slacter
2nd Lou Cooper
3rd Timothy Foltzer
4th Richard Shoemaker
5th Margie Logone

FASTBACK

1st Neil Aly
2nd Glen Bornmann
3rd Earnie Rinaldi
4th John Moody
5th Sammy Hall

COUPE

1st Rick Eldrect
2nd Richard Samuels
3rd Glen Bornmann
4th Wayne Cooper
5th Jim Kelly

CUSTOM

1st Rick Eldrect

SHELBY

1st Tony Logone
2nd Frank Berle

MOST IN NEED

1st Stanley Gibson

We would like to welcome these new members: Gregg D. Gillette, Ernest Rinaldi, Alan and Trisha Hopkins, Robert Donbar, George and Tara Mann.



First Piedmont Regional Group

The First Piedmont Group held its First Annual Rally-Swap Meet July 24 at Scenic Ford in Mt. Airy, North Carolina. We wish to thank everyone for helping out. Your support was very much appreciated. We had a good turn out and a great time. We had fifty Mustangs, several vendors and lots of spectators. This time, we gave three People's Choice trophies in three divisions and a free dash plaque to all participants. The winners are as follows:

Coupe Div., 1965-73
Darlene Scott, Mt. Airy
1965 Coupe
Conv. Div., 1965-73
Caroline Owens, Lawsonville
1966 Conv.
Fastback Div., 1965-73
Marion Hall, Lawsonville, N.C.
1965 Fastback

We signed four new members: Kevin Spainhour, King, N.C.; Joel Timothy Jessup, Mt. Airy; Ray Joseph Gillen, Lexington, N.C.; Richard L. Hodges, Patrick Springs, Va.

Dennis Alley
Secretary & Treasurer

From the National Head Judge

If you would like to receive your judging sheets from any of this year's national shows (Atlanta, Chattanooga or Valley Forge), please send a self addressed envelope with 40¢ postage along with your car entry number to:

Bob Vickery
1470 Stephenson Rd.
Lithonia, GA 30058

All judging sheets will be available until November 15, 1982. After that date, the remaining sheets will be destroyed.

Shelby Owners Reorganized

At the Sixth Annual Shelby Owners of America Convention held in Wichita, Kansas, July 30 - August 1, the membership voted to reorganize.

The reorganization included the election of six members to the Board of Directors: Gary Beers, Terry Buller, Brock McPherson, Jerry Shoemaker, Bob Stapleton, Randy Schwartz and Gerald Wagner as Chairman of the Board.

The purpose of the reorganization of the Shelby Owners of America is to preserve and authenticate Shelby Motor Cars of the years 1965 through 1970, and to serve as an accurate and technical source of information concerning these automobiles for the benefit of its members.



Everybody Sells Parts
We Don't

We Just Offer One of the Most Complete Auto
Restorations You Can Get in the Southeast.

Specializing In
55-56-57 T-Birds
64 thru 73 Mustangs

Tennessee Classic Auto, Inc.
Sales & Restorations
215 James Street
Gallatin, TN 37066
(615) 255-4509

CLASSIFIEDS

Classified advertising is free to Mustang Club of America members. Each member is limited to one thirty (30) word ad per month. Ads to be repeated must be resubmitted each month. Please type all ads submitted if possible. If not, please print ad copy clearly. *Mustang Times* will not be responsible for the correction of illegible ad copy. Please note that commercial advertising is no longer allowed in the classifieds. All ads must relate to Mustangs, Bosses, and Shelbys only.

Correspondence concerning classified advertising should be directed to *Mustang Times*, P.O. Box 447, Lithonia, GA 30358.

CARS FOR SALE

1964½ MUSTANG convertibles. I have 211 260 3 spd. Rangoon Red, completely restored, \$12,000 FIRM. 289, auto., Guardsman blue, new transmission, car needs lots of work, but it's all original. \$1,000 FIRM. Dave Powers, P.O. Box 685, Traverse City, MI 49684. (616) 947-4270 days, 946-8949 evenings.

1964½ MUSTANG conv. White w/new black int., auto, Rally pac, console, ps/b. Exterior chrome new. Orig. tires and wheelcovers. Show winner, trophies included w/car. \$7,500, OBO. (703) 694-3160, 694-3331, 694-6307.

Several MUSTANG convertibles 1964½ (April), \$2,900. 65 w/bench seat, \$2,900, 65 G.T., \$4,900. 66 pony w/factory air, \$2,000. 66 4 spd. 6 cyl. (restored), \$5,500. 1966 MUSTANG bench seat — Equalock coupes (2), \$1,000/\$1,500. (203) 222-1085 (NY).

1965 MUSTANG coupe, white vinyl (good) over navy blue, blue int. (good), 200 6 cyl. Body needs rocker pans, trunk and wheel well panels badly. Mechanically restored. \$1,500/offer. D. Lee (312) 432-6440 evenings.

1965 T5 MUSTANG conv. Caspian blue, white top and int. 6 cyl., auto., power top and console. ALL documentation, very rare car. \$8,500. Also 1966 conv. 46,500 mis. Will sell one car (313) 334-3271. Bob Schuele, 2675 Brady Dr., Bloomfield Hills, MI 48013.

1966 MUSTANG emberglow coupe. 1 owner, 6 cyl., auto. Some exterior rust, rest solid. Mint black int. Stored since 1974. \$2,400 (U.S.) Don Banks, 1527 Blanefield Road, Mississauga, Ont., Canada.

1966 SHELBY 350 GTH. Blue Imron, white stripes. New interior. Thoroughly rebuilt, 289 Hi-Performance short block with Boss 302 heads. Balanced blue printed engine. Accel breakerless ignition. Holley 780 CFM 4 bbl. New headers, 2½" exhausts. Rebuilt C4 transmission (manual override). Konis, Americans, 7" new 205x70VR14 Pirellis. Retirees project car, beautiful. \$9,850.00. 433 Glenheath Drive, Hendersonville, NC 28739. (704) 891-7496.

1966 MUSTANG body. No engine or transmission. Fair cond. \$175. Lloyd Gilbert, 890 Cooper Lake Rd., Smyrna, GA 30080. (404) 435-4141.

1966 MUSTANG hardtop, silver blue, pony interior, 6 cyl., auto., PS, air, 30,000 mi., EC, Florida car. \$5,750.00. (813) 646-5864.

1966 MUSTANG conv. Red, white top, 6 cyl., auto., console, car completely professionally restored. \$5,000 firm. Denise Kiesiver, 135 130 St., Jamaica, L.I., NY 11420. (212) 529-4302.

1967 MUSTANG Lone Star special edition coupe. Rare, EC, \$2,500. Terry Tacker, 1961 River Oaks, Abilene, TX 79605. (915) 692-4926.

MUSTANG OWNERS

65-67 SEAT UPHOLSTERY ONLY 175⁰⁰

NEW! Beautifully detailed heavy gauge vinyl, upholstered seat back panels with new fibre board, ready to install. Seams perfectly embossed, then sewn for correct seam separation, all seams are straight. I installed a set in my Shelby, they look great and fit perfectly. Colors: Black, White, Blue, Red, Palomino, Ivy Gold, Parchment, Turquoise.

2 buckets 127.⁰⁰ 1 bucket 87.⁰⁰
NOTE: specify color, year and body style.

65-68 MOLDED CARPET ONLY 85⁰⁰

Finest quality 100% nylon with reproduction heel and toe pads, die cut holes for shifter, dimmer, seat bolts. Complete with heavy jute underpadding and serge bound. I have put this carpeting in my Shelby, it looks terrific and was easy to install. Colors: Black, Red, Maroon, Lt. Blue, Ford Blue, Dk. Blue, Turquoise, Olive Green, Brown, Saddle, Gold, Emberglow.

coupe or convertible 85.⁰⁰
2 + 2 with fold down and quarter trim prices 100.⁰⁰
NOTE: specify color, year and body style.

65-66 DELUXE PONY UPHOLSTERY ONLY 245⁰⁰

Fronts Only (pair) 165.⁰⁰
One Front Bucket 89.⁰⁰
Rear Only 124.⁰⁰

65-73	Convertible Tops	99. ⁰⁰
65-73	Convertible Top Pads	16. ⁰⁰
65-70	Well Covers	25. ⁰⁰
65-73	Convertible Top Boots	42. ⁰⁰
65-73	Convertible Top Boot Bags	4. ⁰⁰
65-68	Kick Panel Covers (coupe or convt.) set	9. ⁰⁰
65-70	Reproductions Trunk Mats (coupe, convt, fastback)	23. ⁰⁰
65-66	Nos Trunkmats	31. ⁰⁰
65-68	Trunkboards	5. ⁰⁰
	Spare Tire Cover	13. ⁰⁰
65-73	Landau Tops	42. ⁰⁰
	Rear Quarter Trim (convt. & pony coupe)	38. ⁰⁰
65-68	Sunvisors	ea. 23. ⁰⁰
65-70	Headliners (moonskin grain vinyl)	42. ⁰⁰
71-82	Headliners (tier grain vinyl)	42. ⁰⁰
65-68	Torque Box RH or LH	pr. 122. ⁰⁰
65-68	Frame Rails RH or LH	pr. 122. ⁰⁰
65-68	Floor Fans (set of 4/can buy separate)	130. ⁰⁰
65-68	Drain Hole Caps (set of 4 w/screws)	12. ⁰⁰

65-67	Owner's Manuals	6. ⁰⁰
65-66	GT-350 Owner's Manuals	14. ⁰⁰
	How To Restore Your Mustang	16. ⁰⁰
	Mustang Recognition Guide	4. ⁰⁰
	Mustang Value Guide	4. ⁰⁰
	65 Mustang Facts Book	4. ⁰⁰
	66 Mustang Facts Book	4. ⁰⁰
	67 Mustang Facts Book	4. ⁰⁰
	68 Mustang Facts Book	4. ⁰⁰
65-67	License Frames	4. ⁰⁰
65-68	License Plates	4. ⁰⁰
65-66	Battery Tray	Reg. 7" now 6. ⁰⁰
67-70	Battery Tray	Reg. 15" now 14. ⁰⁰
	289 HI PO Air Cleaner (with decal & air filter)	29. ⁰⁰
	8 Cylinder Hose Clamp Kit	15. ⁰⁰
	6 Cylinder Hose Clamp Kit	15. ⁰⁰
	Gas Filter Pipe Wire Hose Clamps	Pr. 5. ⁰⁰
	Grills	
	GT Light Bars	
	Gas Caps	
	Tail Lights	
	Parking Lights	
	Horn Rings	
	Emblems	
	Shelby Parts	
	Weather Strip	
	Locks	
	Luggage Racks	
	Decals	

FREE MUSTANG KEY RING WITH \$30⁰⁰ ORDER

ORDERING INSTRUCTIONS: Please add 10% for shipping and handling (2.⁰⁰ minimum). Florida customers add 5% sales tax. We pay shipping on orders over \$200.⁰⁰.



MUSTANG EXPRESS INC.
Dept. 35
9901 NW 35TH ST. HOLLYWOOD, FL. 33024
1-305 431-7650

Write or phone for FREE catalog. Hundreds of other parts available on request. Charge Customers: send your signature, account # & bank I.D. numbers. Hours: 9 to 5 Mon-Sat No collect calls please

1968 MUSTANG GT conv., auto., air, power discs, radials, AM/FM, 302, 4V, fog lights. GT wheels, black w/black int. and white stripe, GC, needs new top. \$3,750. Carl Collue, 8415 Holly Hill Rd., Richmond, VA 23229. (804) 740-2904.

65-72 MUSTANG bodies. Coupes and fast-backs, \$250 and up, plus delivery. Jim Fears, 3205 W. Clarendon, Dallas, TX 75211.

CARS WANTED

WANTED: 65-68 MUSTANG conv. in need of restoration, within approx. 1 day's drive of Vicksburg, MS. Priced reasonably — floor pan rust O.K. Wes True, Rt. 10, Box 88B2, Vicksburg, MS 39180.

WANTED: 65 or 66 MUSTANG conv., body only, no rust if possible. Must be located in or around North Carolina. Frank Hunt, Box 1041, Marion, NC 28752 (704) 738-4423 (between 8-9 pm).

PARTS WANTED

WANTED: 1965 MUSTANG conv. tinted side glass for both right and left hand vents, doors and quarters. No scratches, nicks or breaks. Must be Carlite. Gene Whiteman, Box 5856, Lynnwood, WA. 98036. (206) 771-2120.

WANTED: 1967 MUSTANG radio and stereo tape player, integral design, console mounted. B. Peters, 3501 NE 21st Ave., Amarillo, TX 79107. (806) 383-3948 (nights).

WANTED: Short block and manifold (or complete engine) for 1965 MUSTANG K 289 Hi Po. George Stevens, 2022 No. Grand, Enid, OK 73701.

WANTED: 65 MUSTANG factory AC (core unit only) for evaporator, new or GC. Jerry Wendell, 5514 Pittman Dr., No., Jacksonville, FL 32207. (904) 733-6930.

PARTS FOR SALE

65½ MUSTANG hood and beveled grill panel, 66 antenna, 65 reg. outside mirror, 64½ air conditioning plate, plastic console plate. M. Davidow, 5N457 Redbud Ct., St. Charles, IL 60174. (312) 377-0126.

NEW!!! **FREE**

MUSTANG

PARTS CATALOG

CALL TOLL FREE *Mustang*
800-227-2174 *Headquarters*

Calif. Toll Free 800-642-2405

2565 Cloverdale Avenue
Concord, California 94518

PARTS DEPARTMENT
Open 9:00 - 5:00 Mon.-Sat.
Order #
(800) 523-6708
Continental USA (Except PA)
Order #
(215) 723-9674
All Other Locations

Glazier's

USED PARTS DEPARTMENT
Open 9:00 - 5:00 Tues.-Sat.
(215) 723-9674

SERVICE DEPARTMENT
Open 8:00 - 5:00 Mon.-Fri.
(215) 723-3722

SPECIALIZING IN PARTS FOR 1965-70 MUSTANGS
531 WAMBOLD ROAD, SOUDERTON, PA 18964
Continental USA (Except PA) 1-800-523-6708
All Other Locations 215-723-9674



"GLAZIER'S GOT 'EM!"

- REPO STYLED STEEL WHEELS**
- 6020 1965 \$445.00*
 - 6021 1966 \$395.00*
 - 6022 1967 \$395.00*
- *set of 4; wheel centers, trim rings, lug nuts not included.
- REPO QUARTER INTERIOR PANELS pr**
- 5260 1965-66 FB RH & LH, fiberglass \$135.00
 - 5261 1965-66 Cvt RH & LH, fiberglass \$115.00
- REPO MUFFLER BRACKET AND INSULATOR ASSEMBLY**
- 6430 1965-66 RH or LH 289 w/dual exhaust
(located rear of each muffler) \$10.00
- REPO HEATER DEFROSTER AIR CHAMBER**
- 3230 1965-69, fiberglass \$60.00

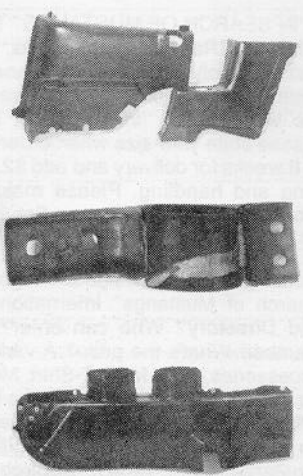

CATALOG AVAILABLE
MC — VISA — COD

One new 65-68 MUSTANG black molded carpet for conv. \$75. 68 factory A/C, dash panels W/standard int. \$110, shipping included. Michael Bland, 616 Pima Dr., San Jose, CA 95123.

Two 67 and two 66 MUSTANG woodgrain steering wheels, no cracks. 1 set of blue center wire spinners, 1 set of 67 styled steel wheels. (206) 847-2623 (8 to 5). Clinton D. Bearteet, Rt. 2, Box 347, Eatonville, WA. 98328.

1967 MUSTANG steering wheel, black, NOS in Ford Box, \$45. (913) 492-8490. John Sell, 12400 W. 100 St. Lewesa, KS 66215.

71-73 MUSTANG folding rear seat (fastback), \$150 plus shipping. Numerous parts for 65-72 models. Jim Fears, 3205 W. Clarendon, Dallas, TX 75211.

MUSTANG center cap for a woodgrain wheel, \$50. Spyder for woodgrain wheel, \$25. 65 styled steel wheel, \$75. Console, nice, \$100. Pistol grip door handles for pony interior, \$25. (904) 398-0341. Don Barry, 2075 Olivia St., Jacksonville, FL 32207.

MISCELLANEOUS

Shelby's Wildlife by Wallace Wyss. *The Cobra Story*. Cost \$16.95, will sell for \$8.50. Boyd Keys, 1248 Laurelwood Rd., Kettering, OH 45409.

New, hand painted Mustang leather key rings \$5. \$7 with a set of Mustang keys. (state year). Childrens, adults' Mustang jackets, lined, washable, racing stripes with Ford and Mustang logos. Ford blue, white stripes. Kids' sizes 6/8, 10/12, 14/16, 18/20, \$20.00. Adult sizes sm., med., lg., ex/lg., \$25.00. Postage prepaid. Knit shirt with embroidered Mustang Logo, sizes s-m-l-xl, \$20. Numbered and signed Mustang, Shelby prints \$15 ea., 2 for \$25. Henry Rasmussen, 1117 Wilderness Tr., Richardson, TX 75080.

"IN SEARCH OF MUSTANGS" T-SHIRTS

White with Red and Blue Figures, 50% cotton and 50% polyester, made by Hanes Shirts, limited quantity at present, \$6.50 each. Let's tell the world about "In Search of Mustangs"! Please state your size when ordering. Allow 6 to 8 weeks for delivery and add \$2.00 for shipping and handling. Please make check or money order out to: James Smart, P.O. Box 342, Salisbury, MD 21801.

Would you like to design the logo for the "In Search of Mustangs" International Registry and Directory? Who can enter? Any MCA member! What's the prize? A variety of MCA accessories — an MCA T-Shirt, MCA Hat and an MCA Front License plate! The logo should tell at a glance what "In Search" is all about. It is an International (Worldwide) Registry and lists Mustangs from 1964½ through 1973. "In Search" is also the first Mustang Registry of its kind. If your logo has that "Something Special," you'll be the proud winner, so, send your logo idea and design today to Jim Smart, P.O. Box 342, Salisbury, MD 21801.

Mr. G's



Mustang City

WRECKING YARD LARGEST IN THE SOUTHWEST

Over 300 Parts Cars. We have thousands of New Parts in Stock. Send large SASE with want list. Call 1-817/838-3131.

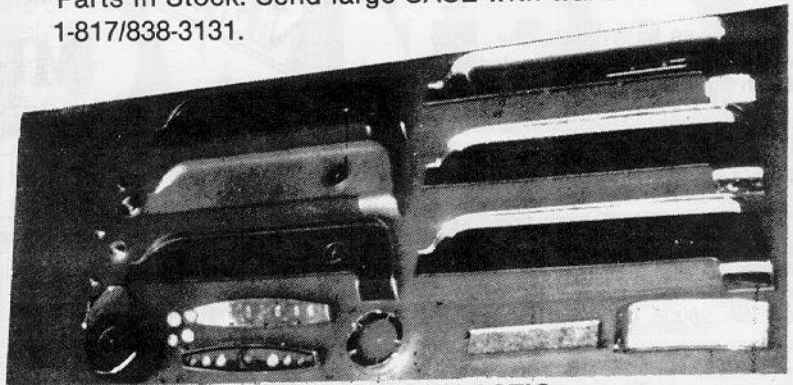

RECHROMED PLASTIC

	RETAIL		RETAIL
65-66 Armrest	\$ 7.50	67-68 Rt. Dash Panel	\$25.00
65-66 Air Registers (\$4.00 ea.)		67-68 Rt. Dash Panel - Painted	
	4 for \$15.00		\$35.00
65- Dash Dial	\$ 2.00	67-68 Rt. Lower Panel	\$10.00
65- Rally Pac Emblem Plate		67-68 Rt. Lower Panel - Painted	
	\$ 4.00		\$15.00
66- Rally Pac Dial	\$ 1.00	67-68 Center Dash Panel	\$ 7.50
66- Rally Pak Ring	\$ 4.00	67-68 Center Dash Panel - Painted	
67- Dash Dial (Large)	\$ 2.00		\$12.50
(Small)	\$ 1.00	67- Horn Ring	\$ 7.50
67- Dome Light Bezel	\$ 5.00	67- Horn Panel	\$ 7.50
65-68 Dash Bezel	\$25.00	Horn Panel Button	\$ 1.00
67-68 Rt. Dash Panel	\$25.00		

*All prices are WITH exchange. Call or write prices on other parts.
NOTE: Do not use tape on these parts. Need to make template or brush paint. Tape pulls off chrome.
Add 10% handling and shipping.



Mr. G's Mustang City

5613 Elliott Reeder Rd.
Ft. Worth, Texas 76117



ORDER TOLL FREE **800/433-7850**

We are determined to exceed the 5000 Mustang mark in the "In Search of Mustangs" International Mustang Registry and Directory. The single biggest entry to "In Search" has been 675 Vehicle I.D. numbers and information. Can you beat this figure? You have SIX MONTHS to do it; contest ends December 31, 1982. Prizes include MCA T-Shirts, hats, license plates, windshield decals, MCA unlined jacket! Remember to get the owner's permission and to send complete information to Jim Smart, P.O. Box 342, Salisbury, MD 21801.

RESTORATIONS • REPAIRS •
DETAILING • MODIFICATION
**64½ - 73 MUSTANGS
SHELBY'S**

CARS & PARTS
BOUGHT • SOLD • TRADED

LEE MATHIAS
3853 MOON STATION RD.
KENNESAW, GA. 30144



Hours
Mon.-Fri. 9-6
Sat. 9-4

1970 INTERIOR TRIM (continued)

BE	Vermillion Vinyl
BF	Ginger Vinyl
BG	Ivy Vinyl
BW	White Vinyl
CE	Vermillion Blazer Stripe
CF	Ginger Blazer Stripe
EA	Black Comfortweave
EB	Blue Comfortweave
EG	Ivy Comfortweave
Ew	White Comfortweave
TA	Black Comfortweave Luxury
TB	Blue Comfortweave Luxury
TG	Ivy Comfortweave Luxury
TW	White Comfortweave Luxury
UE	Vermillion Blazer Stripe
UF	Ginger Blazer Stripe
3A	Black Knitted Vinyl-Mach 1
3B	Blue Knitted Vinyl-Mach 1
3E	Vermillion Knitted Vinyl-Mach 1
3F	Ginger Knitted Vinyl-Mach 1
3G	Ivy Knitted Vinyl-Mach 1
3W	White Knitted Vinyl-Mach 1

1971 INTERIOR TRIM**CODE TRIM DESIGN**

CA	Black Knitted Vinyl
CB	Med. Blue Knitted Vinyl
CE	Vermillion Knitted Vinyl
CF	Med. Ginger Knitted Vinyl
CR	Med. Green Knitted Vinyl
CW	White Knitted Vinyl
1A	Black Vinyl
1B	Med. Blue Vinyl
1E	Vermillion Vinyl
1F	Med. Ginger Vinyl
1R	Med. Green Vinyl
1W	White Vinyl
2B	Med. Blue Cloth-Vinyl
2E	Vermillion Cloth-Vinyl
2F	Med. Ginger Cloth-Vinyl
2R	Med. Green Cloth-Vinyl
3A	Black Knitted Vinyl
3W	White Knitted Vinyl
4A	Black Cloth-Vinyl
4B	Med. Blue Cloth-Vinyl
4E	Vermillion Cloth-Vinyl
4F	Med. Ginger Cloth-Vinyl
4R	Med. Green Cloth-Vinyl
5A	Black Knitted Vinyl
5B	Med. Blue Knitted Vinyl
5E	Vermillion Knitted Vinyl
5F	Med. Ginger Knitted Vinyl
5R	Med. Green Knitted Vinyl
5W	White Knitted Vinyl

1972 INTERIOR TRIM**CODE TRIM DESIGN**

1A	Black Vinyl
1B	Med. Blue Vinyl
1E	Vermillion Vinyl
1F	Med. Ginger Vinyl
1R	Med. Green Vinyl
1W	White Vinyl
2B	Med. Blue Cloth-Vinyl
2E	Vermillion Cloth-Vinyl
2F	Med. Ginger Cloth-Vinyl
2R	Med. Green Cloth-Vinyl
4A	Black Cloth-Vinyl
4B	Med. Blue Cloth-Vinyl
4E	Vermillion Cloth-Vinyl
4F	Med. Ginger Cloth-Vinyl
4R	Med. Green Cloth-Vinyl
5A	Black Knitted Vinyl
5B	Med. Blue Knitted Vinyl
5E	Vermillion Knitted Vinyl
5F	Med. Ginger Knitted Vinyl
5R	Med. Green Knitted Vinyl
5W	White Knitted Vinyl
CA	Black Knitted Vinyl
CB	Med. Blue Knitted Vinyl
CE	Vermillion Knitted Vinyl
CF	Med. Ginger Knitted Vinyl
CR	Med. Green Knitted Vinyl
CW	White Knitted Vinyl
HB	Sprint Decor Option

1973 INTERIOR TRIM**CODE TRIM DESIGN**

AA	Black Vinyl
AB	Med. Blue Vinyl
AF	Med. Ginger Vinyl
AG	Avocado Vinyl
AW	White Vinyl
CA	Black Knitted Vinyl
CB	Med. Blue Knitted Vinyl
CF	Med. Ginger Knitted Vinyl
CG	Avocado Knitted Vinyl
CW	White Knitted Vinyl
FA	Black Cloth-Vinyl
FB	Med. Blue Cloth-Vinyl
FF	Med. Ginger Cloth-Vinyl
FG	Avocado Cloth-Vinyl
GA	Black Knitted Vinyl-Mach 1
GB	Med. Blue Knitted Vinyl-Mach 1
GF	Med. Ginger Knitted Vinyl-Mach 1
GG	Avocado Knitted Vinyl-Mach 1
GW	White Knitted Vinyl-Mach 1

MCA ACCESSORIES

ACCESSORY	QTY.	PRICE
Chilton's 1965-1973 Mustang Tune-Up & Repair Manual (270 pages)	_____	\$ 9.95
Mustang Club of America Cloth 3" Emblem	_____	\$ 2.50
Mustang Club of America Cloth 8" Emblem	_____	\$ 6.00
Mustang Club of America T-Shirt Adult (S-M-L-XL)	_____	\$ 5.00
Mustang Club of America T-Shirt Child (S-M-L-XL)	_____	\$ 4.00
Mustang Club of America Jacket** Unlined — Adult (S-M-L-XL)	_____	\$22.00
Mustang Club of America Winter Jacket** Lined — Adult (S-M-L-XL)	_____	\$29.00
Mustang Club of America Windshield Decal	_____	\$ 1.00
Mustang Club of America Front License Plate	_____	\$ 3.00
Mustang Club of America Official Cap	_____	\$ 5.50
Mustang Club of America Judging Rules	_____	\$ 2.00
DASH PLAQUES		
1978 Kingsport Grand National	_____	\$ 2.00
1979 Atlanta Grand National	_____	\$ 2.00
1979 Chattanooga Spring National	_____	\$ 2.00
1980 Indy Summer National	_____	\$ 2.00
1980 Knoxville Spring National	_____	\$ 2.00
1981 Eastern National	_____	\$ 2.00
1981 Dixie National	_____	\$ 2.00
Back Issues of "The Times"	_____	\$ 2.00

****JACKETS INCLUDE MCA PATCHES**

Due to the rising cost of postage, please add ten percent for shipping.

SEND CHECKS TO:

**MCA ACCESSORIES
% FRANK WHITE
349 Roberts Road
Marietta, GA 30066**



FROM
NATIONAL HEADQUARTERS
THE MUSTANG CLUB OF AMERICA, INC.
P.O. BOX 447
LITHONIA, GEORGIA 30058

C

RUSH TO

